

# Castel

Airco

BY CASTEL ENGINEERING

# The accessories for an easy and complete professional installation

**Castel Engineering** is a Belgian company specialized in the extrusion and injection moulding of plastic parts mainly for the HVAC-R industries. Founded in 1987 as a small company, it has been growing ever since to become a European leader and a standard reference for quality.

The wide variety of product ranges provides high-quality components for clean- and coldroom, panel and refrigerated door manufacturers as well as for the installation of air conditioners.

With ideal locations for logistics, Castel Engineering Group of companies is proud to serve over 70 countries around the world. Castel Engineering Polska Sp zoo, located in Poland, takes care of the Eastern European markets. Rodigas srl, Italian manufacturer and a European leader in the production of brackets for air conditioning installations and many other accessories also for solar photovoltaic applications, joined our group in 2019.

## Disclaimer:

V.2022-I-30-ENG

Hereinafter the terms "we", "our", "ourselves", "us" refer to Castel Engineering sprl and Affiliates or sister companies. The products mentioned in this document are meant to be purchased, installed, periodically checked and maintained only by professionals specialised in Heating, in Ventilation, in Air-Conditioning or in Refrigeration (HVAC-R) that are supposed to have sufficient professional know-how to select the right product according to their intended use and their installation. Any product disposal is at the sole and entire responsibility and expense of the installer, and should be done in respect with all regulations in application at the installation site. We advise our customers to check whether the products they choose are appropriate for their intended use as their application, use, execution, installation and maintenance are carried out of our control.

Those who in any way handle our products are sole responsible for determining (a) the suitability of the products for their intended use, (b) the appropriate manner of processing and maintaining the product to ensure safety and quality and (c) chemical, physical and health effects related to those activities, (d) to inform themselves in order to be able to decide if specific data are necessary prior to their installation in respect to climatic and environment conditions, norms and regulations in application at the locations of storage and installation, (e) to control if the supporting structure on which the product(s) will be installed is resistant enough for the intended use, (f) to use appropriate tools and fixing materials for the installation and for the maintenance. Customers, installers and third parties are sole responsible for damages or failures in performance resulting from misuse, abuse, neglect or improper handling, transporting or storage. Until installed our products must remain in their original packaging, sheltered from climatic conditions. Our warranty is exclusively limited to the supply of a product of constant quality according to our standards. If our product liability is confirmed, the limited warranty will only be such as, at our sole discretion, to make available equivalent or similar replacement goods in conformity to our standards of quality to replace the goods considered faulty. Notwithstanding the care we take to conceive and to manufacture our products, a little difference in the color can be noticed between batches of different production runs.

This is inherent to our production processes and technological limits of our equipment. When mentioned, dimensions are rounded off and are not meant for manufacturing purposes. Tolerances apply. Unless specifically mentioned in the document, all data, whenever a notion of safety factor or safety parameter to be taken into account may implied or requested, is expressed without.

Technical datasheets are available on written request. We reserve us the right to modify all data contained in this document without prior notice. We recommend you contact us before quoting your customers.

The information in this document has been carefully checked and is believed to be accurate. However no responsibility is assumed nor for translating nor typographical nor for proofreading errors neither omissions. Due to the evolution of standards, materials, equipment or other reasons, the characteristics indicated by text or representations or illustrations or drawings and depicted products in this document are not binding for us until our services have specifically confirmed them. Unless otherwise specified, in all our communications, pricelists, quotations, order confirmations and other commercial documents, all our prices are always expressed without taxes.

Purchasing from Castel Engineering sprl or its Affiliates is submitted to its General Conditions of Sale.

They can be found on the website <http://www.castel-engineering.com>

or can be obtained by a simple written request to [info@castel-engineering.com](mailto:info@castel-engineering.com)

All pictures and drawings in this literature are for illustration purposes only. Data may change without prior notice and are subject to tolerances. Castel Engineering Sprl., its Affiliates and its Distributors cannot be held liable for typographical errors, layout errors or technical misinformation contained herein.

**This catalogue cancels and replaces all former versions. It is the sole responsibility of the customers to request to obtain the most recent version in force of this catalogue.**

Copyright © 2022 – Castel Engineering srl – Belgium – [www.castel-engineering.com](http://www.castel-engineering.com) – All rights reserved, including right to translate.

**70**  
COUNTRIES  
AROUND  
THE WORLD



Castel Engineering Belgium



Castel Engineering Polska Sp. z o.o.



Rodigas Srl





SpeediDuct®



Roof Inlet + Flexy Tube



ClimClick® + mini FrameFoot®



Rubberblocks

# 06

ABOUT CASTEL

# 12

CASTEL ENGINEERING DUCTS OVERVIEW

## 06 The company

Our values

Production

Engineering solutions

Manufacturing quality

Fully in-house

Respect for the environment

Protect your linesets

## 14 SpeediDuct®

Installation instructions  
SpeediDuct®  
Flexy Kit  
Parts

## 24 OptimalDuct

Installation instructions  
OptimalDuct  
Flexy Kit  
Parts

## 32 ClimClick®

Installation instructions  
ClimClick®  
Flexy Kit  
Parts

## 40 EcoDuct

Installation instructions  
EcoDuct  
Parts

## 46 ArticaDuct

Installation instructions  
ArticaDuct  
Flexy Kit  
Parts

## 54 CastelPlus®

Floor Supports -  
Mountblocks  
Anti-vibration Pads  
Rubberblocks  
Roof Inlets  
Easybend  
Wall Sleeve - Split Covers  
Roof Bracket  
Vibration Dampers

## 66 AcquaRing®

Installation Instructions  
Rigid Drain Pipes  
Accessories - Parts  
Pre-installation Boxes  
Condensation Trays

## 78 FrameFoot®

FF4  
FF2 Extension Module  
Mini FrameFoot®  
Heat Pump support  
VRF Support

# Castel Engineering

## Our values

As a manufacturer Castel Engineering is aware that modern economy requires constant and swift adaptation, while diversification of the offer will ensure a growing market share.



New rubber production equipment



## Products of very high quality

Though the tendency is towards a never-ending downwards spiral of cheaper products, we commit ourselves to still manufacture products of very high quality. Thanks to full control of our production processes and tool conceptions, we have been able to keep our commitments while remaining the most competitive.



## Stock and transport

Keeping a well-filled stock is another service we provide to our customers. Our H.Q. on-site storage has a capacity of 26.000m<sup>2</sup>. Offering fast and competitive transport solutions is also part of our service.

## A personal approach

We consider it our duty to support our customers with their requests. We are keen on sharing our expertise in order to allow them to opt for the best suitable solution for their projects. Communication is crucial. We take care of every customer with an individual and personal approach. Our multilingual sales team will follow up your requests step by step, so as to understand your needs, advise the selection of the right products, send a quotation and ensure that your order is delivered at your warehouse.



## Production

We have reached an ever growing consumption of 3.500 ton raw materials to feed the machinery park that Castel Engineering currently houses at its H.Q. to serve and extend our offer and services to the customers.

Our Research and Development department, equipped with rapid 3D prototyping equipment, has the task of ensuring that our products keep up with the evolution of technology. Their other key role is to keep on improving existing products and conceiving new ones, with a reduced ecological footprint, complying with new standards.

## Engineering solutions

With over 30 years of experience in plastics processing we have been able to gather and increase the essential knowledge to become and remain a European leader.

We continuously improve our products to offer an up-to-date response to the constantly changing markets.

We have accumulated a respected know-how in tool design which helps optimizing manufacturing costs while enabling us to produce high quality at the most competitive prices. Many satisfied customers have also entrusted us with the conception and manufacturing of some of their OEM components.

//  
**The accessories for  
 an easy and complete  
 professional installation**  
 //

## Manufacturing quality

We can guarantee a high quality of manufacturing thanks to

- > Modern, up-to-date machinery
- > Prime raw materials from renowned industrial suppliers who give us their full support
- > Quality control checks on a regular basis
- > Batch tracing through barcode system.



## Fully in-house

The Castel Engineering group has both extrusion and injection moulding production processes as well as rubberblock manufacturing as expertise, which is exceptional in its sector.

Packing is also done "in-house" which allows quality control over the whole process, from raw material processing to products ready packed for dispatch.

Orders are prepared and shipped on a virtually permanent stock availability.

## Respect for the environment

We are conscious that natural resources on our planet are limited.

Anxious not to waste them we have i.a. :

- > a recycling program that allows us to recover and reuse as much raw materials as possible (i.a. 80 ton rubber per week)
- > packaging, mainly from recycled origin, carefully selected for its minimum ecological footprint
- > invested in solar panels to provide much of our energy requirement
- > been purchasing green energy to cover the rest of our consumption

high quality  
in a trendy look



## Protect your linesets

The insulation of linesets is particularly vulnerable to degradation due to climatic conditions and UV radiation. Without proper protection the insulation may crack and crumble, losing its insulation properties.







## Energy Saver = Cost Saver

Air conditioner and heat pump equipment do not operate properly when linesets or their insulation get damaged.

This may lead to an increased energy consumption and finally to higher maintenance costs or even require an entire unit replacement before its normal end of life.

Our ducts protect your linesets and, in that sense, contribute to save energy and extend the life of your equipment.

## Select the right Castel Engineering Duct!

	SpeediDuct®	OptimalDuct	ClimClick®	EcoDuct	ArticaDuct
					
Type of installation	Premium Top	Smart	Premium Smart	Fast	Fast
Indoor use / outdoor use	■ / ■	■ / ■	■ / ■	■ / ■	■ / ■
Installation speed	++	++	+++	++	++
Installation rigidity	+++	++	+++	++	++
Fitting Assembly	2 parts + screws	1 part clicking	2 parts clicking	1 part clicking	1 part clicking
Duct Length	2 M (6,5 ft)	2 M (6,5 ft)	2 M (6,5 ft)	2 M (6,5 ft)	2 M (6,5 ft)
Fitting assortment in offer	+++	++	++	++	++
Different duct sizes (mm)	70 x 65 mm (2,76 x 2,56") 105 x 75 mm (4,13 x 2,95") 150 x 80 mm (5,91 x 3,15")	60 x 40 mm (2,36 x 1,57") 80 x 60 mm (3,15 x 2,36") 90 x 65 mm (3,54 x 2,56") 110 x 75 mm (4,33 x 2,95")	80 x 60 mm (3,15 x 2,36") 110 x 75 mm (4,33 x 2,95")	80 x 60 mm (3,15 x 2,36") 105 x 60 mm (4,13 x 2,36")	60 x 45 mm (2,36 x 1,77") 80 x 60 mm (3,15 x 2,36") 110 x 75 mm (4,33 x 2,95")
in pure white colour/paintable*	■/■	■/■	■/■	□	□
in ivory colour/paintable*	■/■	□	□	■/■	□
in cream white colour/paintable*	□	□	□	□	■/■
in black colour/paintable*	□	□	■/■	□	□

+++ : super, ++ : medium, ■ : yes, □ : no

ALL TRADEMARKS OWNED BY CASTEL ENGINEERING

+++ : super, ++ : medium, ■ : yes, □ : no

ALL TRADEMARKS OWNED BY CASTEL ENGINEERING

## Better ducts, easier and faster installations

With the SpinFix clip, it's a 1 man job in only 3 steps:

### step 1



Fix the bottom parts of the fittings and the duct to the wall.

### step 2



Place and rotate the SpinFix clip on the rail inside the duct (cable tie open)

### step 3



Place the linesets and other duct contents in the bottom duct and strap the cable tie around them. Avoid crushing the drain hose and linesets!

## Standard colours for Ducts

in pure white colour



in ivory colour



in cream white



in black colour



\* Our ducts can be painted to blend with any exterior/interior colour palette.

In order to ensure good paint adhesion, we recommend following paint manufacturers' instructions for painting plastics (PVC, ASA, PE, PP).

We recommend painting in bright colours only



# SpeediDuct®

Easy to install, fittings  
with screws

Protects the linesets  
and the unit

Helps saving energy

Extends the units life cycle

Aesthetic Design

Paintable

UV-Resistant



SpeediDuct®  
covers it all,  
from the unit  
to the wall



## SpeediDuct® in 3 different sizes



70 x 65 mm (2,76 x 2,56")





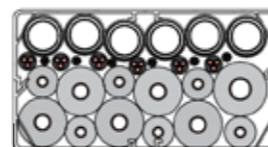

105 x 75 mm (4,13 x 2,95")



150 x 80 mm (5,91 x 3,15")

Depending on installation configurations, ducts' contents may vary.

## Product features and benefits

<b>1 man job</b>	Use the SpinFix-clip to keep ducts contents strapped while installing the cover. Easy and Fast !	
<b>Asymmetrical : Easy when installed in corners</b>	Ducts 70 and 105 have an asymmetrical Design. When installed in corners, the smaller duct top side is easy to clip onto the base channel.	
<b>Up to 150mm wide</b>	Duct size 150 is the widest of its kind, ideal for multi-split or heat pump installations. It has 2 SpinFix rails : 1 in the top and 1 in the base channel	
<b>Rigid installation</b>	Top-Bottom fittings assembled with stainless steel screws ensure a rigid installation	
<b>Large selection of fittings</b>	Not all installations are the same. Some require specific fittings like the soffit inlet, the long flat bend with its larger bending radius for linesets.	

## SpeediDuct®



- > Made of rigid, shockproof, UV-stabilized fire resistant PVC
- > High-quality (usable from -20°C / -4°F to +60°C / 140°F in a static position)
- > Thanks to the inside fixation rail, the SpinFix allows you to use cable ties to strap and keep the linesets in place, contributing to the duct rigidity.

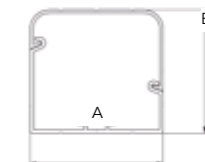

	70	105	150
<b>Model</b>	<b>SP.D.70</b>	<b>SP.D.105</b>	<b>SP.D.150*</b>
Part Nr CW903	0504.00001.013	0504.00101.013	0504.00201.014
Part Nr CI902	0504.00001.011	0504.00101.011	0504.00201.012
A = Width	70mm (2,76")	105mm (4,13")	150mm (5,90")
B = Height	65mm (2,5")	75mm (3")	80mm (3,15")
L=Length	2 M (6,5 ft)	2 M (6,5 ft)	2 M (6,5 ft)
Packing	10 pcs (20 M)	6 pcs (12 M)	5 pcs (10 M)
Pallet	500M (250 pcs / 25 BOX)	300M (150 pcs / 25 BOX)	250M (125 pcs / 25 BOX)



## Spinfix



<b>Model</b>	<b>SFIX1000</b>	<b>SpinFix + Cable Ties SFIXCT100</b>
Part Nr	0508.00008.000	0508.00008.023
Packing	1000 pcs (Without Cable Tie)	10 sets ( 1set = 100x SpinFix & Cable Tie )

## Flexy Kit

Protects your linesets from the condenser unit to the wall.  
Saves time when connecting 2 ducts in special architectural configurations

-  CW903 pure white\*\*
-  CI902 ivory

- > 1x Flexible hose
- > 2x Flex connector
- > 1x Flex-end
- > 1x Stainless steel clamp

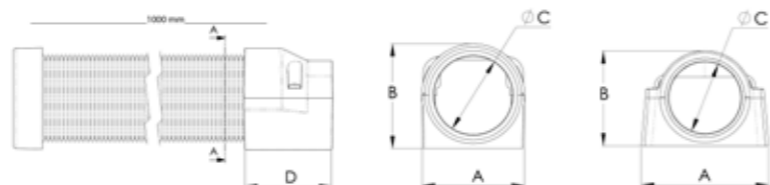

1 kit / box

70

105

Model	SP.FLEX.70	SP.FLEX.105
Part Nr CW903	0504.00021.075	0504.000121.075
Part Nr CI902	0504.00021.072	0504.000121.072
A x B	80 x 80 mm (3,15 x 3,15")	140 x 110 mm (5,51 x 4,33")
C (Inside ø)	60 mm (2,36")	80 mm (3,15")
D	70mm (2,76")	80 x 115 mm (3,15 x 4,53")
Hose length	1 M (3,28 ft)	1 M (3,28 ft)
Packing	1 set	1 set
Pallet	80 sets	80 sets



\*\* Flexible Hose and end cap are always in Ivory (CI902) colour. SEE ALSO OUR OTHER FLEXIBLE SOLUTIONS in section "Castel Plus (R)"



Copyright © 2022 Castel Engineering srl - CAT.AIRCO22v1-1X-F00.000000.020

## Wall Cover

-  CW903 pure white
-  CI902 ivory

> As wall inlet or outlet



70

105

150

Model	SP.WC.70	SP.WC.105	SP.WC.150*
Part Nr CW903	0504.00009.016	0504.00109.016	0504.00209.016
Part Nr CI902	0504.00009.015	0504.00109.015	0504.00209.015
Packing	10 pcs	10 pcs	10 pcs
Pallet	480 pcs	320 pcs	320 pcs

## Connection Piece

-  CW903 pure white (1)
-  CI902 ivory (2)



70

105

150

Model	SP.CP.70	SP.CP.105	SP.CP.150*
Part Nr CW903	0504.00012.016	0504.00112.016	0504.00212.016
Part Nr CI902	0504.00012.015	0504.00112.015	0504.00212.015
Packing	10 pcs	10 pcs	10 pcs
Pallet	840 pcs (1) / 1680 pcs (2)	1680 pcs	840 pcs (1) / 1680 pcs (2)

## Soffit Inlet

-  CW903 pure white
-  CI902 ivory



70

105

Model	SP.SI.70	SP.SI.105
Part Nr CW903	0504.00017.016	0504.00117.016
Part Nr CI902	0504.00017.015	0504.00117.015
Packing	10 pcs	10 pcs
Pallet	640 pcs	480 pcs

\* For SPD150mm (5.9") FITTINGS in CW903 pure white : contact us for availability, MOQ and OIM  
Please respect the recommendations of paint manufacturers for painting PVC, ASA, PE and PP plastics. We recommend painting in bright colours only.

Copyright © 2022 Castel Engineering srl - CAT.AIRCO22v1-1X-F00.000000.020

## Flat Rosette



- > A duct can be mounted flush to the vertical wall while the Flat Rosette covers the hole for the linesets to pass through the ceiling.



70

105

150

Model	SP.FR.70	SP.FR.105	SP.FR.150*
Part Nr CW903	0504.00007.016	0504.00107.016	0504.00207.016
Part Nr CI902	0504.00007.015	0504.00107.015	0504.00207.015
Packing	10 pcs	10 pcs	10 pcs
Pallet	840 pcs	840 pcs (1) / 1680 pcs (2)	840 pcs

## Adjustable Flat Bend



- > Adjustable between 90° and 135°
- > Uneven wall surfaces or specific installations may require SpeediDuct® to be connected at various angles, the adjustable flat bend is the flexible solution for this problem



70

105

Model	SP.AFB.70	SP.AFB.105
Part Nr CW903	0504.00016.016	0504.00116.016
Part Nr CI902	0504.00016.015	0504.00116.015
Packing	10 pcs	10 pcs
Pallet	640 pcs	320 pcs

## 90° Flat Bend



70

105

150

Model	SP.FB.70	SP.FB.105	SP.FB.150*
Part Nr CW903	0504.00005.016	0504.00105.016	0504.00205.016
Part Nr CI902	0504.00005.015	0504.00105.015	0504.00205.015
Packing	10 pcs	10 pcs	10 pcs
Pallet	640 pcs	640 pcs	320 pcs

## 45° Flat Bend



70

105

150

Model	SP.FB45.70	SP.FB45.105	SP.FB45.150*
Part Nr CW903	0504.00004.016	0504.00104.016	0504.00204.016
Part Nr CI902	0504.00004.015	0504.00104.015	0504.00204.015
Packing	10 pcs	10 pcs	10 pcs
Pallet	320 pcs	480 pcs	480 pcs

## 90° Outside Elbow Bend



- > To place around the outside corner



70

105

150

Model	SP.EIN.70	SP.EIN.105	SP.EIN.150*
Part Nr CW903	0504.00003.016	0504.00103.016	0504.00203.016
Part Nr CI902	0504.00003.015	0504.00103.015	0504.00203.015
Packing	10 pcs	10 pcs	10 pcs
Pallet	640 pcs	480 pcs	480 pcs

## 90° Inside Elbow Bend



- > To place inside the internal corner



70

105

150

Model	SP.EB.70	SP.EB.105	SP.EB.150*
Part Nr CW903	0504.00002.016	0504.00102.016	0504.00202.016
Part Nr CI902	0504.00002.015	0504.00102.015	0504.00202.015
Packing	10 pcs	10 pcs	10 pcs
Pallet	640 pcs	480 pcs	480 pcs

## 90° Long Flat Bend



- > Thicker insulated linesets may require a bigger bend radius. This part is the best solution to avoid crushing them.

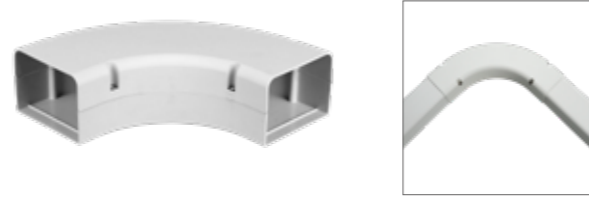

70

105

150

Model	SP.LFB.70	SP.LFB.105	SP.LFB.150*
Part Nr CW903	0504.00008.016	0504.00108.016	0504.00208.016
Part Nr CI902	0504.00008.015	0504.00108.015	0504.00208.015
Packing	10 pcs	10 pcs	10 pcs
Pallet	320 pcs	320 pcs	320 pcs

## T-Joint



For Multi-split Systems / Reducer joints are required when combining

- > a duct of 70mm/3" with a duct of 105mm/4"
- > a duct of 105mm/4" with a duct of 150mm/6"

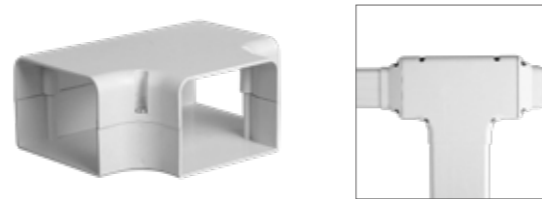

105

150

Model	SPTJ.105	SPTJ.150*
Part Nr CW903	0504.00115.016	0504.00215.016
Part Nr CI902	0504.00115.015	0504.00215.015
Packing	10 pcs	10 pcs
Pallet	480 pcs	320 pcs

## Reducer Joint



- > To combine with a T-joint



105

150

Model	SP.RJ.70.105	SP.RJ.105.150*
Part Nr CW903	0504.00011.016	0504.00111.073
Part Nr CI902	0504.00011.015	0504.00111.016
Packing	10 pcs	10 pcs
Pallet	840 pcs (1) / 1680 pcs (2)	320 pcs (1) / 640 pcs (2)

\* For SPD150mm (5.9") FITTINGS in CW903 pure white : contact us for availability, MOQ and OIM  
Please respect the recommendations of paint manufacturers for painting PVC, ASA, PE and PP plastics. We recommend painting in bright colours only.

## Duct Cap

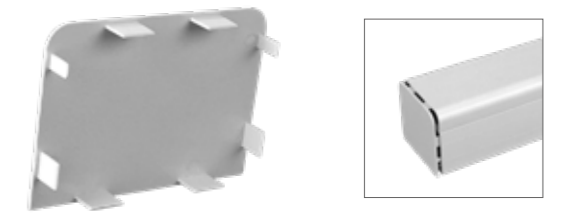
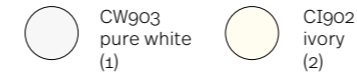

70

105

150

Model	SP.DC.70	SP.DC.105	SP.DC.150*
Part Nr CW903	0504.00013.016	0504.00113.016	0504.00213.016
Part Nr CI902	0504.00013.015	0504.00113.015	0504.00213.015
Packing	10 pcs	10 pcs	10 pcs
Pallet	840 pcs (1) / 1680 pcs (2)	840 pcs (1) / 1680 pcs (2)	840 pcs

## Duct End

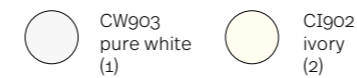

70

105

150

Model	SP.DE.70	SP.DE.105	SP.DE.150*
Part Nr CW903	0504.00014.016	0504.00114.016	0504.00214.016
Part Nr CI902	0504.00014.015	0504.00114.015	0504.00214.015
Packing	10 pcs	10 pcs	10 pcs
Pallet	320 pcs (1) / 640 pcs (2)	480 pcs	320 pcs

## Wall Rosette

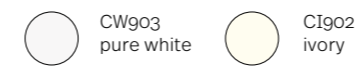

70

105

150

Model	SP.WR.70	SP.WR.105	SP.WR.150*
Part Nr CW903	0504.00010.016	0504.00110.016	0504.00210.016
Part Nr CI902	0504.00010.015	0504.00110.015	0504.00210.015
Packing	10 pcs	10 pcs	10 pcs
Pallet	840 pcs	840 pcs	320 pcs

\* For SPD150mm (5.9") FITTINGS in CW903 pure white : contact us for availability, MOQ and OIM  
Please respect the recommendations of paint manufacturers for painting PVC, ASA, PE and PP plastics. We recommend painting in bright colours only.

# *OptimalDuct*

- Easy & Fast installation
- Protects the linesets and the unit
- Saves energy
- Extends the units life cycle
- Aesthetic Design
- Paintable
- UV-Resistant



the optimal way to  
protect your installation

## OptimalDuct in 4 different sizes



Depending on installation configurations, ducts' contents may vary.

## Product features and benefits

<b>1 man job</b>	Use the SpinFix-clip to keep ducts contents strapped while installing the cover. Easy and Fast !	
<b>Protective Film</b>	Dirty hands while installing ? No worries ! Just remove the protective film from the ducts.	
<b>Wide selection of duct sizes</b>	Choose among the 4 different duct sizes available for your professional installation !	
<b>Fast installation</b>	Just click the fittings onto the duct to complete the installation.	

## OptimalDuct

CW903  
pure white

Black\*  
\*See ClimClick\* offer pg 35



- > In pure white
- > With protective film.
- > Made of rigid PVC, UV-resistant.
- > High quality (usable from -20°C / -4°F to +60°C / 140°F in a static position).
- > Thanks to the inside fixation rail, the SpinFix allows you to use cable ties to strap and keep the linesets in place, contributing to the duct rigidity.



Model	ODF.60	ODF.80	ODF.90	ODF.110
Part Nr CW903	0505.00001.017	0505.00101.018	0505.00201.018	0505.00301.019
A = Width	60 mm (2,36")	80 mm (3,15")	90 mm (3,54")	110 mm (4,33")
B = Height	40 mm (1,57")	60 mm (2,36")	65 mm (2,56")	75 mm (2,95")
L=Length	2 M (6,5 ft)	2 M (6,5 ft)	2 M (6,5 ft)	2 M (6,5 ft)
Packing	12 pcs (24M)	8 pcs (16M)	8 pcs (16M)	4 pcs (8M)
Pallet	960 M (480pcs / 40 box)	560 M (280 pcs / 35 box)	400 M (200 pcs / 25 box)	320 M ( 160 pcs / 40 box)

## Spinfix



Model	SFIX1000	SpinFix + Cable Ties SFIXCT100
Part Nr	0508.00008.000	0508.00008.023
Packing	1000 pcs (Without Cable Tie)	10 sets ( 1set = 100x SpinFix & Cable Tie )

## Flexy Kit

Protects your linesets from the external unit to the wall. Saving time when connecting 2 ducts is an art!

 CW903 pure white\*

- > 1x Flexible hose
- > 2x Flex connector
- > 1x Flex-end
- > 1x Stainless steel clamp



1 kit / box

	<b>80</b>	<b>110</b>
<b>Model</b>	<b>OD.FLEX.80</b>	<b>OD.FLEX.110</b>
Part Nr CW903	0505.00114.072	0505.00314.072
A x B	100 x 80 mm (3,94 x 3,15")	120 x 90 mm (4,72 x 3,54")
C (Inside ø)	60 mm (2,36")	80 mm (3,15")
D	90 mm (3,54")	110 mm (4,33")
Hose length	1 M (3,28 ft)	1 M (3,28 ft)
Packing	1 set	1 set
Pallet	80 sets	80 sets

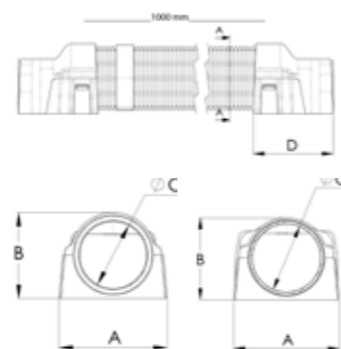

\* Flexible Hose and end cap are always in ivory (CI902) colour. SEE ALSO OUR OTHER FLEXIBLE SOLUTIONS in section "Castel Plus (R)"



## Adjustable Flat Elbow

 CW903 pure white

- > Adjustable between 90° and 135°
- > Uneven wall surfaces or specific installation require OptimalDuct® to be connected at various angles, the adjustable flat bend is the flexible solution for this problem

	<b>80</b>
<b>Model</b>	<b>ODAFE.80</b>
Part Nr CW903	0505.00115.015
Packing	10 pcs
Pallet	TBC



## Connection Piece

 CW903 pure white

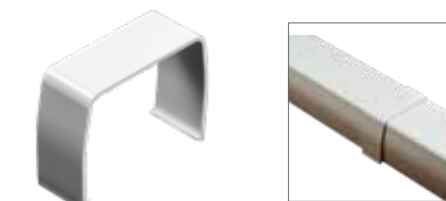

	<b>60</b>	<b>80</b>	<b>90</b>	<b>110</b>
<b>Model</b>	<b>ODC.60</b>	<b>ODC.80</b>	<b>ODC.90</b>	<b>ODC.110*</b>
Part Nr CW903	0505.00003.015	0505.00103.015	0505.00203.015	0505.00303.015
Packing	10 pcs	10 pcs	10 pcs	10 pcs
Pallet	840 pcs	1680 pcs	1680 pcs	1680 pcs

## End Cap

 CW903 pure white



	<b>60</b>	<b>80</b>	<b>90</b>	<b>110</b>
<b>Model</b>	<b>ODEC.60</b>	<b>ODEC.80</b>	<b>ODEC.90</b>	<b>ODEC.110</b>
Part Nr CW903	0505.00005.015	0505.00105.015	0505.00205.015	0505.00305.015
Packing	10 pcs	10 pcs	10 pcs	10 pcs
Pallet	840 pcs	1680 pcs	1680 pcs	640 pcs

## Wall Cover

 CW903 pure white



	<b>60</b>	<b>80</b>	<b>90</b>	<b>110</b>
<b>Model</b>	<b>ODWC.60</b>	<b>ODWC.80</b>	<b>ODWC.90</b>	<b>ODWC.110*</b>
Part Nr CW903	0505.00008.015	0505.00110.015	0505.00210.015	0505.00310.015
Packing	10 pcs	10 pcs	10 pcs	10 pcs
Pallet	1680 pcs	640 pcs	640 pcs	640 pcs

\* new part design

## 90° Flat Elbow

 CW903 pure white

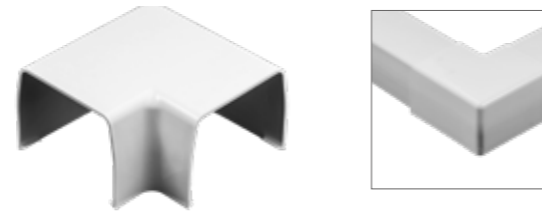

60

80

90

110

Model	ODFE.60	ODFE.80	ODFE.90	ODFE.110
Part Nr CW903	0505.00006.015	0505.00106.015	0505.00206.015	0505.00306.015
Packing	10 pcs	10 pcs	10 pcs	10 pcs
Pallet	840 pcs	640 pcs	640 pcs	640 pcs

## 90° Elbow Bend Inside

 CW903 pure white

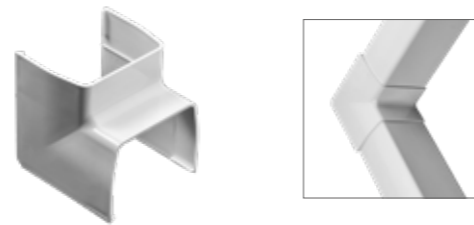

60

80

90

110

Model	ODIC.60	ODIC.80	ODIC.90	ODIC.110
Part Nr CW903	0505.00007.015	0505.00107.015	0505.00207.015	0505.00307.015
Packing	10 pcs	10 pcs	10 pcs	10 pcs
Pallet	840 pcs	1680 pcs	640 pcs	640 pcs

## 90° Elbow Bend Outside

 CW903 pure white

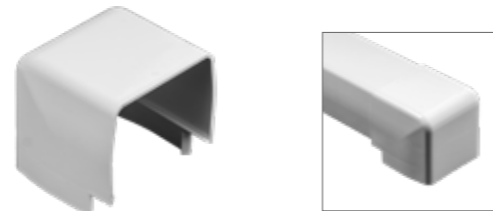

60

80

90

110

Model	ODCO.60	ODCO.80	ODCO.90	ODCO.110
Part Nr CW903	0505.00004.015	0505.00104.015	0505.00204.015	0505.00304.015
Packing	10 pcs	10 pcs	10 pcs	10 pcs
Pallet	840 pcs	1680 pcs	1680 pcs	640 pcs

Copyright © 2022 Castel Engineering srl - CAT.AIRCO22v1-1X-F00.00000.020

## Duct Reducer

 CW903 pure white



80

110

110

Model	ODRJ.80.60	ODRJ.110.80	ODRJ.110.90
Part Nr CW903	0505.00108.015	0505.00112.015	0505.00212.015
Packing	10 pcs	10 pcs	10 pcs
Pallet	840 pcs	1680 pcs	840 pcs

## Flat Wall Rosette

 CW903 pure white

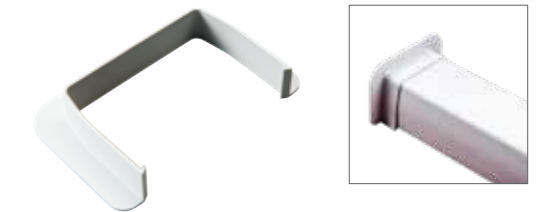

60

80

90

110

Model	ODWR.60	ODWR.80	ODWR.90	ODWR.110*
Part Nr CW903	0505.00009.015	0505.00111.015	0505.00211.015	0505.00311.015
Packing	10 pcs	10 pcs	10 pcs	10 pcs
Pallet	840 pcs	1680 pcs	840 pcs	840 pcs

## T-Joint

 CW903 pure white

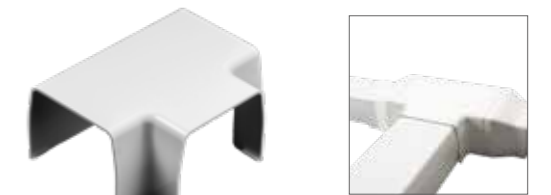

80

90

110

Model	ODTJ.80	ODTJ.90	ODTJ.110
Part Nr CW903	0505.00109.015	0505.00209.015	0505.00309.015
Packing	10 pcs	10 pcs	10 pcs
Pallet	640 pcs	640 pcs	640 pcs

\* new part design

Copyright © 2022 Castel Engineering srl - CAT.AIRCO22v1-1X-F00.00000.020



**ClimClick®**

Easy installation and super fast Click system

Premium fittings upgrade for Optimal Duct sizes 80 and 110

"Click and Done": mount without screws

Paintable

UV-resistant

**NEW**  
**ClimClick®**  
**IN BLACK**

protect  
your linesets  
in just  
one Click!

## A super fast installation thanks to "click-fittings" and SpinFix.

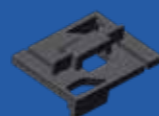

### step 1

Fix the bottom parts and the duct to the wall (screws not provided). Easy and fast 'center to center' connection inside the Ducts.



### step 2

Place a cable tie in the SpinFix and insert and rotate the SpinFix onto the rail at the bottom of the Duct and ClimClick® fittings.



### step 3

Lay the lineset, drain hose inside the duct, strap the cable tie around them without damaging neither deforming them. Cut off any excess of cable tie.



### step 4

Cover with the top part of the Duct and remove the protection film.

Duct contents may vary according to installation configurations.



### step 5

Install the fitting top (cover). No screws needed = clicking system



### optional step\*

Paint OptimalDuct® to match the wall colour.

## Product features and benefits

<p><b>Smart for a Fast installation</b></p>	<p>A) Climclick® fittings guide ducts postioning</p> <p>B) Spinfix holders with "center to center" indications</p>	
<p><b>Premium fittings for a rigid installation</b></p>	<p>Finish your installation in just a few seconds !</p> <p>Just click the top parts of the fittings over the ducts.</p>	
<p><b>Also available in BLACK</b></p>	<p>Black fittings are individually packed in bags : no finger prints</p>	

## ClimClick® fittings are compatible with OptimalDuct sizes 80 and 110



Depending on installation configurations, ducts' contents may vary.

## OptimalDuct®

- > With protective film.
- > Made of rigid PVC, UV-resistant.
- > High quality (usable from -20°C/-4°F to +60°C/140°F in a static position).
- > Thanks to the inside fixation rail, the SpinFix allows you to use cable ties to strap and keep the linesets in place, contributing to the duct rigidity.

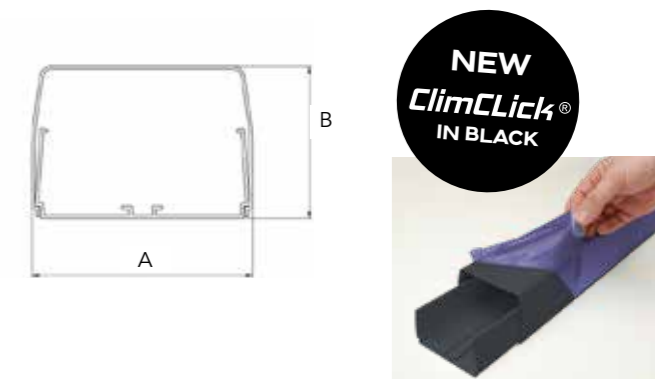

○ CW903 pure white    ● NEW Black

Model	ODF.80	ODF.110
Part Nr CW903	0505.00101.018	0505.00301.019
Part Nr Black	0505.00101.031	0505.00301.031
A = Width	80 mm (3,15")	110 mm (4,33")
B = Height	60 mm (2,36")	75 mm (2,95")
L=Length	2 M (6,5 ft)	2 M (6,5 ft)
Packing	8 pcs (16M)	4 pcs (8M)
Pallet	560 M (280 pcs / 35 box)	320 M (160 pcs / 40 box)

## SpinFix

Model	SFIX1000	SpinFix + Cable Ties SFIXCT100
Part Nr	0508.00008.000	0508.00008.023
Packing	1000 pcs (Without Cable Tie)	10 sets ( 1set = 100x SpinFix & Cable Tie)

\* Please respect the recommendations of paint manufacturers for painting PVC, ASA, PE and PP plastics. We recommend painting in bright colours only.

## Wall cover

○ CW903 pure white ● **NEW** Black

	80	110
Model	ODWC.80	ODWC.110*
Part Nr CW903	0505.00110.015	0505.00310.015
Part Nr Black	0505.00110.031	0505.00310.031
Packing	10 pcs	10 pcs
Pallet	640 pcs	640 pcs



## Connection Piece

○ CW903 pure white ● **NEW** Black

	80	110
Model	CCDC.80	CCDC.110
Part Nr CW903	0505.00580.000	0505.00585.000
Part Nr Black	0505.00580.031	0505.00585.031
Packing	6 pcs	6 pcs
Pallet	1008 pcs	384 pcs



## Flat Wall Rosette

○ CW903 pure white ● **NEW** Black

	80	110
Model	ODWR.80	ODWR.110*
Part Nr CW903	0505.00111.015	0505.00311.015
Part Nr Black	0505.00111.031	0505.00311.031
Packing	10 pcs	10 pcs
Pallet	1680 pcs	840 pcs



## 90° Flat Elbow

○ CW903 pure white ● **NEW** Black

	80	110
Model	CCDFE.80	CCDFE.110
Part Nr CW903	0505.00582.000	0505.00587.000
Part Nr Black	0505.00582.031	0505.00587.031
Packing	6 pcs	6 pcs
Pallet	384 pcs	288 pcs



## 90° Outside Corner

○ CW903 pure white ● **NEW** Black

	80	110
Model	CCDCO.80	CCDCO.110
Part Nr CW903	0505.00581.000	0505.00586.000
Part Nr Black	0505.00581.031	0505.00586.031
Packing	6 pcs	6 pcs
Pallet	384 pcs	384 pcs



## 90° Inside Corner

○ CW903 pure white ● **NEW** Black

	80	110
Model	CCDCI.80	CCDCI.110
Part Nr CW903	0505.00583.000	0505.00588.000
Part Nr Black	0505.00583.031	0505.00588.031
Packing	6 pcs	6 pcs
Pallet	384 pcs	288 pcs



## T-Joint

○ CW903 pure white ● **NEW** Black

	80	110
Model	CCDTJ.80	CCDTJ.110
Part Nr CW903	0505.00584.000	0505.00589.000
Part Nr Black	0505.00584.031	0505.00589.031
Packing	6 pcs	6 pcs
Pallet	384 pcs	192 pcs



## Duct Reducer

○ CW903 pure white ● **NEW** Black

	110
Model	ODRJ.110-80
Part Nr CW903	0505.00112.015
Part Nr Black	0505.00112.031
Packing	10 pcs
Pallet	1680 pcs

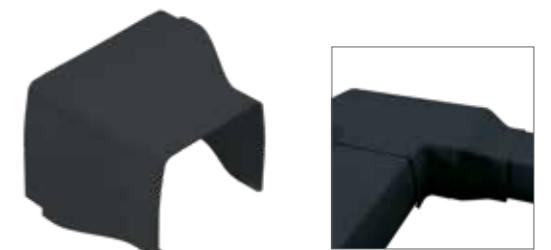

## Duct End

CW903 pure white

80

110



Model	CCDDE.80*	CCDDE.110*
Part Nr CW903	0505.00590.000	0505.00591.000
Packing	6 pcs	6 pcs
Pallet	384 pcs	1008 pcs

\*These models are available ON REQUEST  
Please respect the recommendations of paint manufacturers for painting PVC, ASA, PE and PP plastics. We recommend painting in bright colours only.

## Flexy Kit

1 kit / box

Protects your linesets from the condenser unit to the wall.  
Saves time when connecting 2 ducts in special architectural configurations

CW903 pure white\*\*



- > 1x Flexible hose
- > 2x Flex connector
- > 1x Flex-end
- > 1x Stainless steel clamp

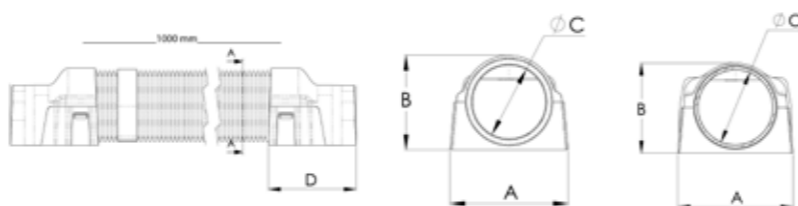

80

110

Model	OD.FLEX.80	OD.FLEX.110
Part Nr CW903	0505.00114.072	0505.00314.072
A x B	100 x 80 mm (3,94 x 3,15")	120 x 90 mm (4,72 x 3,54")
C (Inside ø)	60 mm (2,36")	80 mm (3,15")
D	90 mm (3,54")	110 mm (4,33")
Hose length	1 M (3,28 ft)	1 M (3,28 ft)
Packing	1 set	1 set
Pallet	80 sets	80 sets



\*\* Flexible Hose and end cap are always in ivory (C1902) colour. SEE ALSO OUR OTHER FLEXIBLE SOLUTIONS in section "Castel Plus (R)"

Copyright © 2022 Castel Engineering srl - CAT.AIRCO22v1-1X-F00.000000.020

## Rodigas®



Rodigas manufactures als Certified Quality products for



[www.rodigas.it](http://www.rodigas.it)

Copyright © 2022 Castel Engineering srl - CAT.AIRCO22v1-1X-F00.000000.020

# EcoDuct

- Easy and Fast to install
- Protects the linesets and the unit
- Helps saving energy
- Extends the units life cycle
- Aesthetic Design
- Paintable
- UV-Resistant

protects your installation  
and your equipment

**Panasonic** 280106-01  
MULTI-SPLIT AIR-CONDITIONER  
MODEL NO. CU-PE23CBPQ SERIAL NO. 6306511535  
RATED VOLTAGE 220V~50Hz PRODUCTION SWIT  
REFRIGERANT R410A THE CAPACITY CURRENT AND POWER INPUT ARE  
FOR THIS UNIT CONNECTED TO THE FOLLOWING  
COOLING CAPACITY 2.30 kW ROOM SIZES CS-620KXW CS-610KXW  
CURRENT 8.2 A CS-610KXW CS-610KXW  
POWER INPUT 1.86 kW FOR OTHER COMBINATIONS, REFER TO MANUAL  
HEATING CAPACITY 8.80 kW  
CURRENT 8.3 A  
POWER INPUT 1.48 kW  
M.P.A. 4.35 MPa  
E.E.P. 2.52 MPa  
SOUND POWER LEVEL COOLING 51.0 dB(A)  
HEATING 52.0 dB(A)

62 Btu/h

OUTSIDE MODEL  
BE USED TO ESTIMATE  
FROM THE PROPOSED  
BE WITHIN ACCEPTABLE LIMITS  
BEFORE INSTALLATION

MODEL NO. CU-PE23CBPQ  
INDUSTRIAL CO., LTD.

# Install Eco Duct in 5 easy steps with the SpinFix!



## step 1

Fix the bottom parts and the duct to the wall. (Screws are not included.)



## step 2

Place a cable tie in the SpinFix and insert and rotate the SpinFix onto the rail at the bottom of the Duct.



## step 3

Lay the lineset, drain hose inside the duct, strap the cable tie around them without damaging them. Cut off any excess of cable tie.



## step 4

Cover with the top part of the Duct and remove the \*\*protective film



## step 5

Install the fitting top (cover). No screws needed = clicking system.



## Optional step\*

Paint the Duct to match the wall colour.

Duct contents may vary according to installation configurations.

\* Please respect the recommendations of paint manufacturers for painting PVC, ASA, PE and PP plastics. We recommend painting in bright colours only.  
\*\* Protective film : applies only to EDBEDC.80

Copyright © 2022 Castel Engineering srl - CAT.AIRCO22v1-1X-F00.000000.020

# EcoDuct



Duct contents may vary according to installation configurations.

- > Material: Rigid PVC shockproof, UV stabilized, fire resistant
- > Allows a wide range of temperatures (-20° / +60°C in a static position)
- > Thanks to the inside fixation rail, the SpinFix allows you to use cable ties to strap and keep the linesets in place, contributing to the duct rigidity.



● C1902 Ivory white

	80	105
<b>Model</b>	<b>EDB.EDC.80 **</b>	<b>EDB.EDC.105</b>
Part Nr C1902	0507.00001.021	0507.00101.021
A (Width)	80 mm (3.15")	105 mm (4.13")
B (Height)	60 mm (2.36")	60 mm (2.36")
L=Length	2 M (6,5 ft)	2 M (6,5 feet)
Packing	8 pcs (16 M)	6 pcs (12 M)
Pallet	400 M (200 pcs / 25 BOX)	300 M (150 pcs / 25 BOX)

# Spinfix



<b>Model</b>	<b>SFIX1000</b>	<b>SpinFix + Cable Ties SFIXCT100</b>
Part Nr	0508.00008.000	0508.00008.023
Packing	1000 pcs (Without Cable Tie)	10 sets ( 1set = 100x SpinFix & Cable Tie )

\*\* Protective film : applies only to EDBEDC.80

Copyright © 2022 Castel Engineering srl - CAT.AIRCO22v1-1X-F00.000000.020

## Eco Wall Cover

 CI902 Ivory white

	80	105
<b>Model</b>	<b>EWC.80</b>	<b>EWC.105</b>
Part Nr	0507.00007.022	0507.00107.022
Packing	20 pcs	20 pcs
Pallet	960 pcs	960 pcs



## Eco corner-In

 CI902 Ivory white

	80	105
<b>Model</b>	<b>ECI.80</b>	<b>ECI.105</b>
Part Nr	0507.00004.022	0507.00104.022
Packing	20 pcs	20 pcs
Pallet	960 pcs	960 pcs



## Eco Flat Rosette

 CI902 Ivory white

	80	105
<b>Model</b>	<b>EFR.80</b>	<b>EFR.105</b>
Part Nr	0507.00009.022	0507.00109.022
Packing	20 pcs	20 pcs
Pallet	1680 pcs	640 pcs



## Eco Corner-Out

 CI902 Ivory white

	80	105
<b>Model</b>	<b>ECO.80</b>	<b>ECO.105</b>
Part Nr	0507.00005.022	0507.00105.022
Packing	20 pcs	20 pcs
Pallet	1280 pcs	480 pcs



## Eco Cap

 CI902 Ivory white

	80	105
<b>Model</b>	<b>ECAP.80</b>	<b>ECAP.105</b>
Part Nr	0507.00002.022	0507.00102.022
Packing	20 pcs	20 pcs
Pallet	1680 pcs	1680 pcs



## Eco Flat Elbow

 CI902 Ivory white

	80	105
<b>Model</b>	<b>EFE.80</b>	<b>EFE.105</b>
Part Nr	0507.00006.022	0507.00106.022
Packing	20 pcs	20 pcs
Pallet	960 pcs	960 pcs



## Eco Connect

 CI902 Ivory white

	80	105
<b>Model</b>	<b>ECON.80</b>	<b>ECON.105</b>
Part Nr	0507.00003.022	0507.00103.022
Packing	20 pcs	20 pcs
Pallet	1680 pcs	1680 pcs



## Eco T-Junction

 CI902 Ivory white

	80	105
<b>Model</b>	<b>ETJ.80</b>	<b>ETJ.105</b>
Part Nr	0507.00008.022	0507.00108.022
Packing	20 pcs	20 pcs
Pallet	640 pcs	480 pcs



# ArticaDuct

- Easy and Fast to install
- Protects the linesets and the unit
- Helps saving energy
- Extends the units life cycle
- Aesthetic Design
- Paintable
- UV-Resistant



aesthetically  
protects your  
installation



# Install Artica Duct in 5 easy steps with the SpinFix.



## step 1

Fix the bottom parts and the duct to the wall. (Screws are not included.)



## step 2

Place a cable tie in the SpinFix and insert and rotate the SpinFix onto the rail at the bottom of the Duct.



## step 3

Lay the lineset, drain hose inside the duct, strap the cable tie around them without damaging neither deforming them. Cut off any excess of cable tie.



## step 4

Cover with the top part of the Duct and remove the protective film.



## step 5

Install the fitting top (cover). No screws needed = clicking system.



## Optional step\*

Paint the Duct to match the wall colour.

Duct contents may vary according to installation configurations.

\* Please respect the recommendations of paint manufacturers for painting PVC, ASA, PE and PP plastics. We recommend painting in bright colours only.

# ArticaDuct

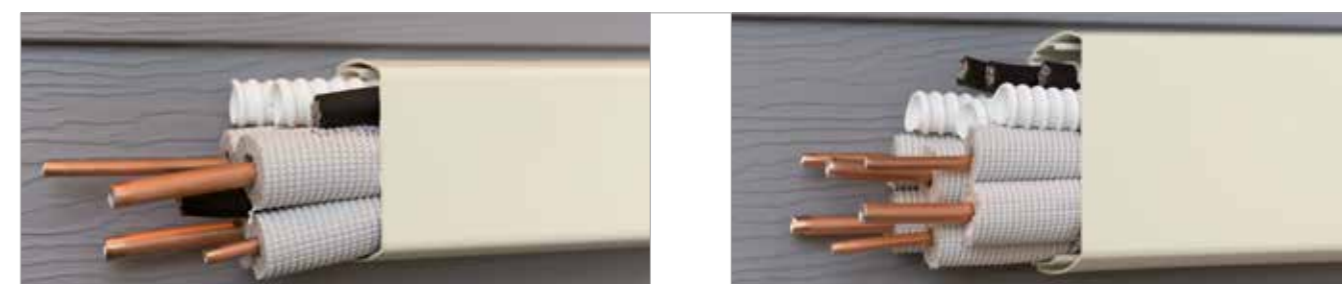

60 x 45 mm (2.36 x 1.77")	80 x 60 mm (3.15 x 2.36")	110 x 75 mm (4.33 x 2.95")

Depending on installation configurations, ducts' contents may vary.

- > Made of rigid, shockproof, UV-stabilized fire resistant PVC
- > High-quality (usable from -20°C / -4°F to +60°C / 140°F in a static position-
- > Thanks to the inside fixation rail, the SpinFix allows you to use cable ties to strap and keep the linesets in place, contributing to the duct rigidity.
- > helps saving energy : linesets are protected against UV damage and climatic conditions

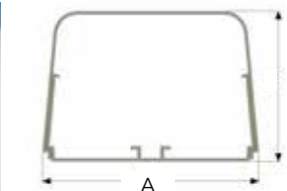

	60	80	110
<b>Model</b>	<b>AFR.60</b>	<b>AFR.80</b>	<b>AFR.110</b>
Part Nr	0515.00001.017	0515.00101.018	0515.00201.019
A = Width	60 mm (2,36")	80 mm (3,15")	110 mm (4,33")
B = Height	40 mm (1,57")	60 mm (2,36")	75 mm (2,95")
L=Length	2 M (6,5 ft)	2 M (6,5 ft)	2 M (6,5 ft)
Packing	12 pcs (24M)	8 pcs (16M)	4 pcs (8M)
Pallet	960 M (480 pcs / 40 BOX)	640 M (320 pcs / 40 BOX)	320 M (160 pcs / 40 BOX)

# Spinfix



Model	SFIX1000	SpinFix + Cable Ties SFIXCT100
Part Nr	0508.00008.000	0508.00008.023
Packing	1000 pcs (Without Cable Tie)	10 sets ( 1set = 100x SpinFix & Cable Tie )

## Connection Piece

 C1901 cream white

	60	80	110
<b>Model</b>	<b>CLC.60</b>	<b>CLC.80</b>	<b>CLC.110</b>
Part Nr	0515.00003.066	0515.00103.066	0515.00203.022
Packing	30 pcs	30 pcs	20 pcs
Pallet	2520 pcs	5040 pcs	1680 pcs



## End Cap

 C1901 cream white

	60	80	110
<b>Model</b>	<b>CLEC.60</b>	<b>CLEC.80</b>	<b>CLEC.110</b>
Part Nr	0515.00005.020	0515.00105.065	0515.00205.063
Packing	12 pcs	9 pcs	6 pcs
Pallet	1008 pcs	1512 pcs	1008 pcs



## 90° Internal Corner

 C1901 cream white

	60	80	110
<b>Model</b>	<b>CLIC.60</b>	<b>CLIC.80</b>	<b>CLIC.110</b>
Part Nr	0515.00007.064	0515.00107.063	0515.00207.062
Packing	8 pcs	6 pcs	4 pcs
Pallet	1344 pcs	1008 pcs	672 pcs



## Wall Cover In/Out

 C1901 cream white

	60	80	110
<b>Model</b>	<b>CLWC.60</b>	<b>CLWC.80</b>	<b>CLWC.110</b>
Part Nr	0515.00008.065	0515.00108.063	0515.00208.062
Packing	9 pcs	6 pcs	4 pcs
Pallet	756 pcs	1008 pcs	672 pcs



## 90° External Corner

 C1901 cream white

	60	80	110
<b>Model</b>	<b>CLCO.60</b>	<b>CLCO.80</b>	<b>CLCO.110</b>
Part Nr	0515.00004.020	0515.00104.065	0515.00204.063
Packing	12 pcs	9 pcs	6 pcs
Pallet	1008 pcs	1512 pcs	1008 pcs



## Flat Rosette

 C1901 cream white

	60	80	110
<b>Model</b>	<b>CLFR.60</b>	<b>CLFR.80</b>	<b>CLFR.110</b>
Part Nr	0515.00009.015	0515.00109.064	0515.00209.064
Packing	10 pcs	8 pcs	8 pcs
Pallet	840 pcs	1344 pcs	1344 pcs



## 90° Flat Elbow

 C1901 cream white

	60	80	110
<b>Model</b>	<b>CLFE.60</b>	<b>CLFE.80</b>	<b>CLFE.110</b>
Part Nr	0515.00006.015	0515.00106.064	0515.00206.063
Packing	10 pcs	8 pcs	6 pcs
Pallet	1680 pcs	512 pcs	384 pcs



## T-Junction

 C1901 cream white

	80	110
<b>Model</b>	<b>CLTJ.80</b>	<b>CLTJ.110</b>
Part Nr	0515.00110.062	0515.00210.037
Packing	4 pcs	2 pcs
Pallet	672 pcs	128 pcs



## Reduction

To be used in combination with the T-JUNCTION

C1901 cream white

	80	110
<b>Model</b>	<b>CLRJ.80-60</b>	<b>CLRJ.110-80</b>
Part Nr	0515.00111.020	0515.00211.064
Packing	12 pcs	8 pcs
Pallet	1008 pcs	1344 pcs



## Adjustable Flat Elbow

C1901 cream white

	80	110
<b>Model</b>	<b>CLAFE.80</b>	<b>CLAFE.110</b>
Part Nr	0515.00112.063	0515.00212.062
Packing	6 pcs	4 pcs
Pallet	1008 pcs	672 pcs



**Flexy Cover kit**  
The direct  
through the wall  
solution!  
See page 56



Copyright © 2022 Castel Engineering srl - CAT.AIRCO22v1-1X-F00.000000.020

Copyright © 2022 Castel Engineering srl - CAT.AIRCO22v1-1X-F00.000000.020

## Flexy Kit

1 kit / box

Protects your linesets from the condenser unit to the wall.  
Saves time when connecting 2 ducts in special architectural configurations

C1901 cream white\*

- > 1x Flexible hose
- > 2x Flex connector
- > 1x Flex-end
- > 1x Stainless steel clamp

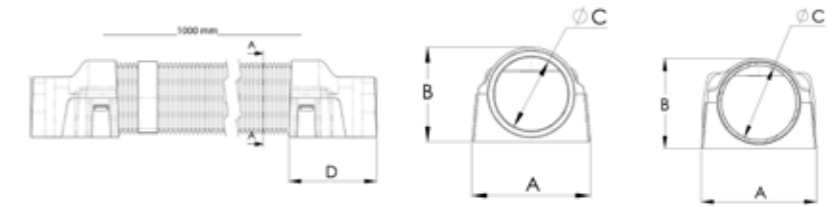

	80	110
<b>Model</b>	<b>AD.FLEX.80</b>	<b>AD.FLEX.110</b>
Part Nr	0515.00114.072	0515.00214.072
A x B	100 x 80 mm (3,94 x 3,15")	120 x 90 mm (4,72 x 3,54")
C (Inside ø)	60 mm (2,36")	80 mm (3,15")
D	90 mm (3,54")	110 mm (4,33")
Hose length	1 M (3,28 ft)	1 M (3,28 ft)
Packing	1 set	1 set
Pallet	80 sets	80 sets

\* Flexible Hose and end cap are always in ivory (C1902) colour. SEE ALSO OUR OTHER FLEXIBLE SOLUTIONS in section "Castel Plus"



# Castel Plus®

Roof inlets  
Easybend®  
Wall sleeve  
Split covers  
Anti vibration pads  
Roof supports



protect the linesets  
running the roof  
with Flexy Tube  
see next pages →

## Flexy Cover Kit

The NEW cover kit , also for HEAT PUMPTS  
Protects your linesets from the external unit to the wall when no ducts are needed.

 CI902 ivory

- > 1x Wall connection piece
- > 1x Flexible hose
- > 1x Stretchable End cap

Model	FCK.75
Part Nr	0508.00004.000
Diameter ø	80mm (3,15")
Flexible Length	1 M ( 3,28 ft )
Packing	1 BOX
Pallet	80 BOX



Copyright © 2022 Castel Engineering srl - CAT.AIRCO22v1-1X-F00.000000.020

## Flexy Tube

50 M long flexible hose to cover and protect your linesets.  
Ideal for long linesets running on roofs

 CI902 ivory



Model	FLEX.60	FLEX.80
Part Nr	0103.00597.000	0103.00596.000
Diameter ø	60mm (3,15")	80mm (2,36")
Flexible Length	50 M (164,04 ft)	50 M (164,04 ft)
Packing	ROLL of 50 M (164,04 ft)	ROLL of 50 M (164,04 ft)
Packing	1 ROLL	1 ROLL
Pallet	6 ROLL (300 M)	5 ROLL (250 M)



Copyright © 2022 Castel Engineering srl - CAT.AIRCO22v1-1X-F00.000000.020

See also our Flexy Kit offers for our ducts

## Mountblocks Heavy Duty 100mm



- > 360 kg / 794 lbs max. allowable spread-load capacity per item\*
- > Condenser unit fixation bolts included
- > Packaged in pairs
- > Suitable for a large range of units (mounting rail feature)
- > High quality (usable from -20°C/-4°F to +60°C/140°F in a static position)
- > UV Resistant



Model	EX.38-350	EX.B38-450	EX.A38-1000
Part Nr CW	0502.00001.007	0502.00002.007	0502.00003.0009
Part Nr Black	0502.00001.008	0502.00002.0008	0502.00003.010
Length	350mm (13,78")	450mm (17,72")	1000mm (39,37")
Width x Height	100x100mm (3,94 x 3,94")	100x100mm (3,94 x 3,94")	100x100mm (3,94 x 3,94")
Packing	1 BOX = 6 x 2 pcs	1 BOX = 6 x 2 pcs	1 BOX = 2 pcs
Pallet	48 BOX (576 pcs)	40 BOX (480 pcs)	95 BOX (490 pcs)

## Mountblocks Eco 100mm



- > 160 kg / 350 lbs max. allowable spread-load capacity per item\*
- > Suitable for a large range of units (mounting rail feature)
- > High quality (usable from -20°C/-4°F to +60°C/140°F in a static position)
- > UV Resistant
- > Condenser unit fixation bolts included



Model	EX.83-350**	EX.C83-450	EX.A83-1000**
Part Nr CW	0502.00007.007	0502.00008.007	0502.00009.009
Part Nr Black	0502.00007.008	0502.00008.008	0502.00010.010
Length	350mm (13,78")	450mm (17,72")	1000mm (39,37")
Width x Height	100x100mm (3,94 x 3,94")	100x100mm (3,94 x 3,94")	100x100mm (3,94 x 3,94")
Packing	1 BOX = 6 x 2 pcs	1 BOX = 6 x 2 pcs	1 BOX = 2 pcs
Pallet	48 BOX (576 pcs)	40 BOX (480 pcs)	95 BOX (490 pcs)

\* Based on tests carried out on 450mm model. Check safety parameters that are appropriate for your intended use and contact us if necessary.  
\*\* Available only on request

## Mountblock Mini 80mm



- > 120 kg / 265 lbs max. allowable spread-load capacity per item\*
- > Unit fixation bolts included
- > Suitable for a large range of units (mounting rail feature)
- > High-quality (usable from -20°C/-4°F to +60°C/140°F in a static position)

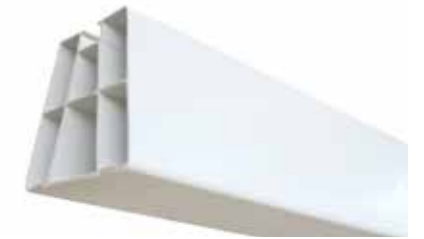

Model	EX.137-350	EX.B137-450	EX.A137-1000
Part Nr CW	0502.00012.007	0502.00013.008	0502.00017.009
Length	350mm (13,78")	450mm (17,72")	1000mm (39,37")
Width x Height	80x80mm (3,15 x 3,15")	80x80mm (3,15 x 3,15")	80x80mm (3,15 x 3,15")
Packing	1 BOX = 6 x 2 pcs	1 BOX = 6 x 2 pcs	1 BOX = 2 pcs
Pallet	63 BOX (756 pcs)	55 BOX (660 pcs)	95 BOX (490 pcs)

## Mountblock End Cap

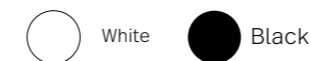

- > For Mountblock Heavy Duty (EX.38) and Mountblock Eco (EX.83)



Model	INJ.181
Part Nr CW	0502.00018.036
Part Nr Black	0502.00018.040
Small Packing	1 SET = 4 pcs
Packing	25 SETS (100 pcs)

## Mountblock End Cap 'Mini'



- > For Mountblock Mini (EX.137)



Model	INJ.437
Part Nr CW	0502.00019.036
Small Packing	1 SET = 4 pcs
Packing	25 SETS (100 pcs)

## Mountblock Fixation Kit

- > The solution to secure the mountblocks to the ground\*\*



A.12

Model	A.12
Part Nr	0502.00020.000
Set contents	4 fixation plates + 4 anchor bolts
Small Packing	1 SET in a bag
Packing	25 SETS

\* Based on tests carried out on 450mm model. Check safety parameters that are appropriate for your intended use and contact us if necessary.

## Anti-vibration Pads

- > Performs better than rubber or cork for equivalent size
- > Special composite foam core
- > More efficient than solid rubber vibration damping
- > Ideal for vibration suppression of residential-packaged condensing units



Model	MP-2E	MP-3E	MP-4E	MP-6E
Part Nr	0901.00001.E02	0901.00001.E03	0901.00001.E04	0901.00001.E06
Dimensions (mm)	50 x 50 x 22 mm	75 x 75 x 22 mm	100 x 100 x 22 mm	150 x 150 x 22 mm
Dimensions (inch)	1,97 x 1,97 x 0,87"	2,95 x 2,95 x 0,87"	3,94 x 3,94 x 0,87"	5,90 x 5,90 x 0,87"
Packing	48 pcs	36 pcs	24 pcs	24 pcs
PALLET	8640 pcs	4320 pcs	2400 pcs	864 pcs



Copyright © 2022 Castel Engineering srl - CAT.AIRCO22v1-1X-F00.000000.020

## Rubber Blocks

- > Universal rail: 42 x 22 mm (for other rail design, contact us)
- > Widths : 180 mm or 130 mm
- > Bolt set is included (not in riser blocks)
- > Blocks strapped per pair (not the risers)



Model	RB25-0/180	RB40-0/180	RB60-0/180	RB100-0/180
Part Nr	0502.02528.000	0502.04028.000	0502.06028.000	0502.01028.000
Length x Width x Height	250 x 180 x 95 mm	400 x 180 x 95 mm	600 x 180 x 95 mm	1000 x 180 x 95 mm
Length x Width x Height	9,84 x 7,09 x 3,74"	15,75 x 7,09 x 3,74"	23,62 x 7,09 x 3,74"	39,37 x 7,09 x 3,74"
Spread Load /pc	120 kg	180 kg	300 kg	350 kg
Packing	1 SET = 2 pcs	1 SET = 2 pcs	1 SET = 2 pcs	1 SET = 2 pcs
Pallet	90 SETS (180 pcs)	60 SETS (120 pcs)	40 SETS (80 pcs)	20 SETS (40 pcs)

Model	RB25-1/130	RB40-1/130	RB60-1/130	RB100-1/130,
Part Nr	0502.12528.000	0502.14028.000	0502.16028.000	0502.11028.000
Length x Width x Height	250 x 130 x 95 mm	400 x 130 x 95 mm	600 x 130 x 95 mm	1000 x 130 x 95 mm
Length x Width x Height	9,84 x 5,12 x 3,74"	15,75 x 5,12 x 3,74"	23,62 x 5,12 x 3,74"	39,37 x 5,12 x 3,74"
Spread Load /pc	120 kg	180 kg	300 kg	350 kg
Packing	1 SET = 2 pcs	1 SET = 2 pcs	1 SET = 2 pcs	1 SET = 2 pcs
Pallet	135 SETS (270 pcs)	90 SETS (180 pcs)	60 SETS (120 pcs)	36 SETS (72 pcs)

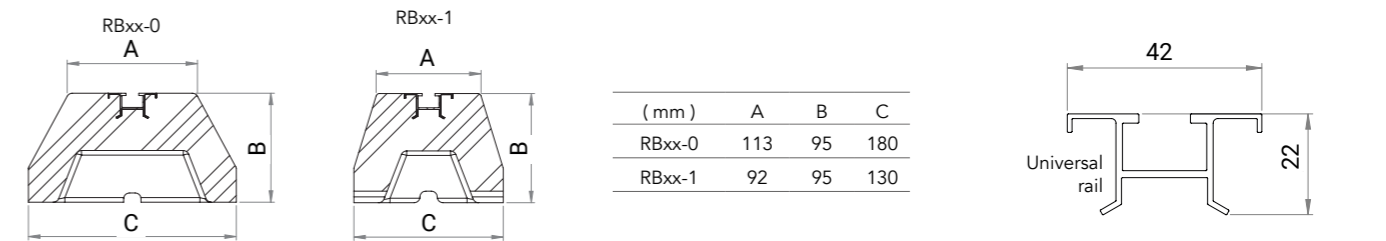

Model	RB-RISER 60-0/180	RB-RISER 100-0/180
Part Nr	0502.26028.000	0502.21028.000
Length x Width x Height	600 x 180 x 105 mm	1000 x 180 x 105 mm
Length x Width x Height	23,62 x 7,09 x 4,13"	39,37 x 7,09 x 4,13"
Spread Load /pc	300 kg	300 kg
Packing	1 pc	1 pc
Pallet	72 pcs	36 pcs

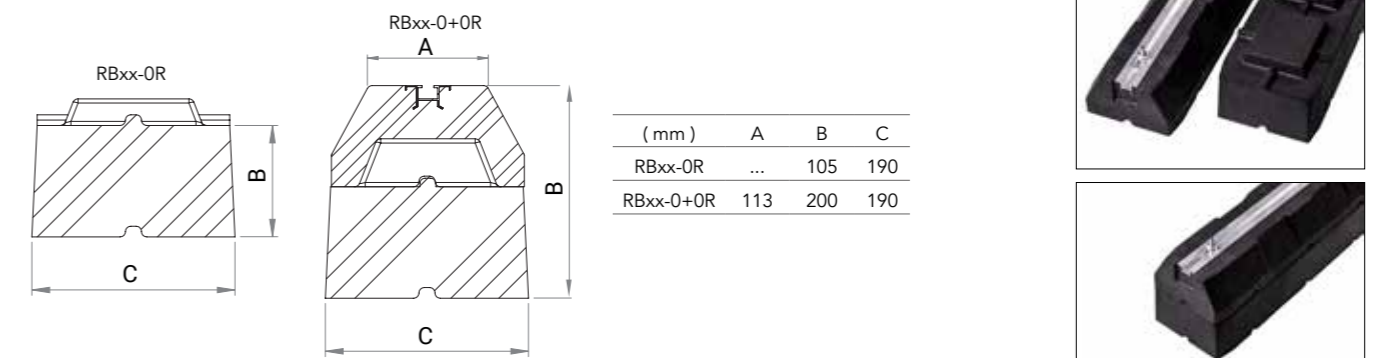

## Roof Inlet



White

- > The right solution for rooftop installation requiring linesets to run through the roof.

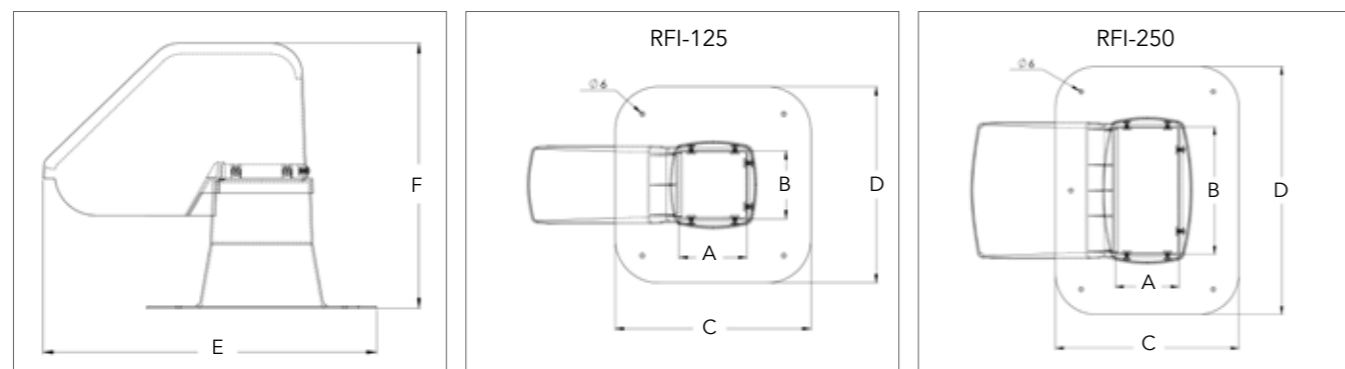

Model	RFI-125	RFI-250
Part Nr	0508.00007.037	0508.00006.037
Colour	white	white
Inside dimensions A x B	125 x 125 mm (4,92 x 4,92")	125 x 250 mm (4,92 x 9,84")
Outside dimensions C x D	360 x 360 mm (14,17 x 14,17")	360 x 490 mm (14,17 x 19,29")
Outside dimensions E x F	520 x 415 mm (20,47 x 16,34")	530 x 420 mm (20,87 x 16,54")
Packing	1 PC	1 PC
Pallet	30 PCS	32 PCS

SEE ALSO OUR OTHER FLEXIBLE ROLLS in previous pages of this section "Castel Plus"

## Easybend

Air conditioning lineset bender  
No more kinks or leaks when bending your linesets

- > The tool that you need to bend linesets when installing split systems
- > Easiest way to bend dual tubes without damaging their insulation
- > Reusable after cleaning!
- > No need for springs or heavy equipment!
- > Only for linesets made from soft copper



Insert the flexible bender of the right diameter into the copper tube



Bend to required angle.



Retract the flexible bender.



Reusable if kept clean. The benders are ready for the next installation.



No more kinks or leaks when bending your linesets



Scan QR-code and watch the easy-to-use video

Model	EZB				EZB-XT*
Part Nr	0508.00010.000				0508.00011.000
Colour	Red	Green	Yellow	Blue	White
ø (mm) fits tube	4mm for 1/4"	6mm for 3/8"	9mm for 1/2"	12mm for 5/8"	16mm for 3/4"
Length	4 M (13,12 ft)	4 M (13,12 ft)	4 M (13,12 ft)	4 M (13,12 ft)	4 M (13,12 ft)
Small Packing	1 SET contains the 4 different diameters (=colours) / BAG				1 SET per BAG
Packing	15 SETS / BOX				10 SETS / BOX
PALLET	135 SETS				90 SETS



## Wall Sleeve



White

- > Protects the insulation of the lineset tubes from damage when passing through the wall
- > The collar covers indoor drill imperfections
- > Cut to adjust to wall thickness, between 100mm / 3,94" and 350mm / 13,78"
- > The hole should be made with a diameter of 64mm / 2.52"

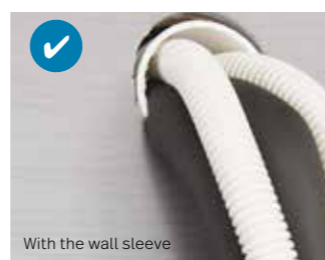
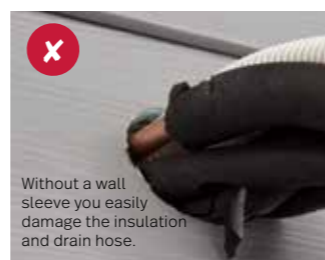
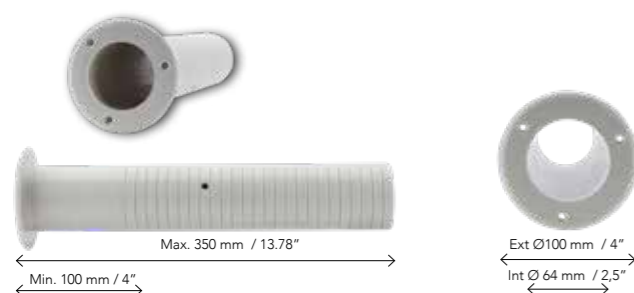

Model	WSLV
Part Nr	0508.00005.028
Colour	white
Packing	10 pcs
PALLET	320 pcs

## Split Covers

- > Protects your installation while minimizing its visual impact
- > Made from treated wood (for outdoor use)
- > Easy & fast installation
- > Inclined roof avoiding water stagnation
- > Can be painted if required
- > Allows air flow
- > Stainless steel screws

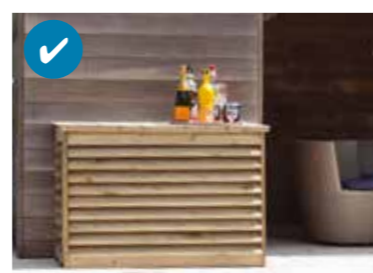
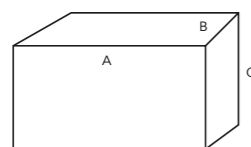

Model	SPC700	SPC950	SP1600
Part Nr	0516.00001.000	0516.00001.001	0516.00001.002
Outside Width (A)	1110mm (43,31")	1160mm (45,67")	1360mm (53,54")
Inside Width (A)	950mm (37,40")	1000mm (39,37")	1200mm (47,22")
Outside Depth (B)	580mm (22,83")	580mm (22,83")	580mm (22,83")
Inside Depth (B)	540mm (21,26")	540mm (21,26")	540mm (21,26")
Outside Height ( C )	740mm (29,13")	990mm (38,98")	1580mm (62,20")
Inside Height ( C )	720mm (38,35")	970mm (38,19")	1560mm (61,42")
Packing	10 pcs / PAL	10 pcs / PAL	5 pcs / PAL

Copyright © 2022 Castel Engineering srl - CAT.AIRCO22v1-1X-F00.00000.020

## Roof Bracket

- > Adjustable for sloped roof (min 9°, max 45°)
- > Galvanized steel, powder coated ivory white
- > With vibration damping accessories



Model	MT650
Part Nr	0501.00016.059
Colour	ivory white
Crossbar	800mm (31,50")
Arm Length	520mm (20,47")
Max spread load *capacity	140 kg (308,6 lbs)
Packing	1 PC
PALLET	108 pcs

## Vibration Dampers

- > Rubber vibration dampers.
- > Manufactured from natural rubber (55° Sh A)
- > External M8-male threaded rod + nuts + washers
- > Foreseen to combine with brackets



Model	BVDCO	BVDCY	FVDCO
part Nr	0503.00002.006	0503.00001.006	0503.00003.006
Part shape	Conical	Cylindrical	Foot
Dimensions (rubber body) mm	30 x 45 x 25 (h)mm	30 x 30 x 30 (h) mm	35 x 50 x 15 (h) mm
Dimensions (rubber body) (")	1,18 x 1,77 x 0,99" (h) inch	1,18 x 1,18 x 1,18" inch	1,38 x 1,97 x 0,59" (h)
Thread	M8	M8	M8
Max spread load*capacity	150 kg (330 lbs) / SET	150 kg (330 lbs) / SET	150 kg (330 lbs) / SET
Packing	4 pcs / SET	4 pcs / SET	4 pcs / SET
Small Packing	50 SETS (200 pcs)	50 SETS (200 pcs)	75 SETS (300 pcs)
PAL	1800 SETS (36 BOX)	2400 SETS (48 BOX)	1800 SETS (24 BOX)

\* Maximum spread load capacity : expressed for spread loading both arms of the bracket

Copyright © 2022 Castel Engineering srl - CAT.AIRCO22v1-1X-F00.00000.020

# AcquaRing®

- No glue needed
- Saves installation time
- Connects rigid pipes with hoses
- Easy to (re)adjust
- Convenient connecting



quick and easy  
products for condensate  
water removal

## AcquaRing® system

- > No glue = **no waiting time** = fast installation
- > No glue = **(re)adjustable and extendable**
- > With **pre-mounted O-ring**
- > **Pre-lubricated for easy connection**

**no  
glue!**



### step 1

Cut



### step 2

Chamfer and deburr



### step 3

Pre-mounted O-ring and pre-lubricated



### step 4

Connect



Scan QR-code and watch  
the easy-to-use video

Designed for use only for  
air conditioning condensation  
water without any pressure

## Rigid Drain Pipes \*/\*\*



White

- > Made of rigid, self-extinguishing PVC
- > No glue needed, fast installation
- > Chamfer and deburr before inserting into a fitting
- > We recommend the use of non-aggressive installation grease
- > Designed for use only for air conditioning condensation water without any pressure



> 32 mm

25 mm

20 mm

## NO GLUE NEEDED

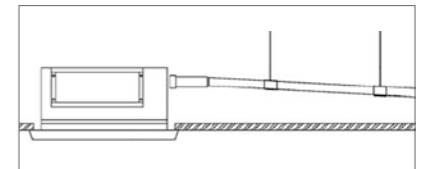

Model	RDP.20	RDP.25	RDP.32
Part Nr	0513.00001.021	0513.00101.021	0513.00201.021
Colour	white	white	white
L=Length	2 M	2 M	2 M
External diameter	20 mm	25mm	32mm
Internal Diameter	18mm	22,5mm	29mm
Packing	100M (50 pcs)	60M (30 pcs)	40M (20 pcs)
PALLET	4000M (2000 pcs)	2400M (1200 pcs)	1600M (800 pcs)

\* Pre-mounted and pre-lubricated O-rings : CHAMFER and DEBURR the pipe before inserting it in fittings to avoid damage to the O-rings !  
\*\* To be used only for the outlet of air conditioning condensation water (without pressure)

## RDP 45° Connection\*/\*\*

○ White



Model	RDP20-C45	RDP25-C45	RDP32-C45
part Nr	0513.00002.022	0513.00102.022	0513.00202.022
Colour	white	white	white
Packing	240 pcs (12 x 20)	200 pcs (10 x 20)	100 pcs (5 x 20)
PALLET	7680 pcs (32 BOX)	6400 pcs (32 BOX)	3200 pcs (32 BOX)

## RDP 90° Connection\*/\*\*

○ White



Model	RDP20-C90	RDP25-C90	RDP32-C90
Part Nr	0513.00003.022	0513.00103.022	0513.00203.022
Colour	white	white	white
Packing	240 pcs (12 x 20)	140 pcs (7 x 20)	100 pcs (5 x 20)
PALLET	7680 pcs (32 BOX)	4480 pcs (32 BOX)	3200 pcs (32 BOX)

## RDP T-connection\*/\*\*

○ White



Model	RDP20-T	RDP25-T	RDP32-T
Part Nr	0513.00005.022	0513.00105.022	0513.00205.022
Colour	white	white	white
Packing	160 pcs (8 x 20)	100 pcs (5 x 20)	60 pcs (3 x 20)
PALLET	5120 pcs (32 BOX)	3200 pcs (32 BOX)	1920 pcs (32 BOX)

## RDP Extension\*/\*\*

○ White



Model	RDP20-XT	RDP25-XT	RDP32-XT
part Nr	0513.00006.022	0513.00106.022	0513.00206.022
Colour	white	white	white
Packing	240 pcs (12 x 20)	200 pcs (10 x 20)	100 pcs (5 x 20)
PALLET	7680 pcs (32 BOX)	6400 pcs (32 BOX)	3200 pcs (32 BOX)

## Reducer\*/\*\*

○ White



Model	RDP25-20 RD	RDP32-25 RD
part Nr	0513.00107.022	0513.00207.022
Colour	white	white
Packing	200 pcs (10 x 20)	100 pcs (5 x 20)
PALLET	12800 pcs (64 BOX)	6400 pcs (64 BOX)

## RDP-Clip

○ White

> For wall and ceiling



Model	RDP20-CLIP	RDP25-CLIP	RDP32-CLIP
Part Nr	0513.00004.022	0513.00104.022	0513.00204.022
Colour	white	white	white
Packing	500 pcs (25 x 20)	500 pcs (25 x 20)	500 pcs (25 x 20)
PALLET	32000 (64 BOX)	32000 (64 BOX)	24000 (48 BOX)

## Transparent Sifon\*\*

NEW

○ Transparent

- > Avoids bad smells!
- > Can only be installed vertically
- > Transparent for an easy inspection

Model	RDP-SIF-V
Part Nr	0514.00008.022
Colour	Transparent
A = Internal Ø	for 16 / 18 / 20 mm
B = External Ø	for 16 / 18 / 20 mm
Packing	20 PC
Pallet	960 pcs (48 BOX)



## Tray Outlet Connection\*\*

○ White

- > For a professional connection to a drain pan

Model	TO25
Part Nr	0513.00544.000
Colour	white
Connection Ø	20mm
Packing	100 x 1 pc
Pallet	6400 pcs (64 BOX)

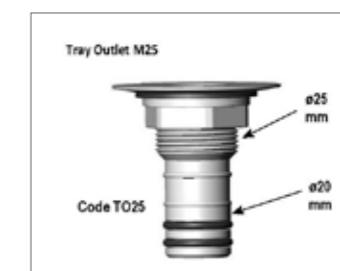

\* Pre-mounted and pre-lubricated O-rings : CHAMFER and DEBURR the pipe before inserting it in fittings to avoid damage to the O-rings !  
\*\* To be used only for the outlet of air conditioning condensation water (without pressure)

\* Pre-mounted and pre-lubricated O-rings : CHAMFER and DEBURR the pipe before inserting it in fittings to avoid damage to the O-rings !  
\*\* To be used only for the outlet of air conditioning condensation water (without pressure)

## RDP Sifon\*/\*\*

○ White

- > Avoids bad smells!
- > Can be installed vertically and horizontally
- > Various connection combinations possible. Contact us
- > Inspectable



### Maintenance & Inspection

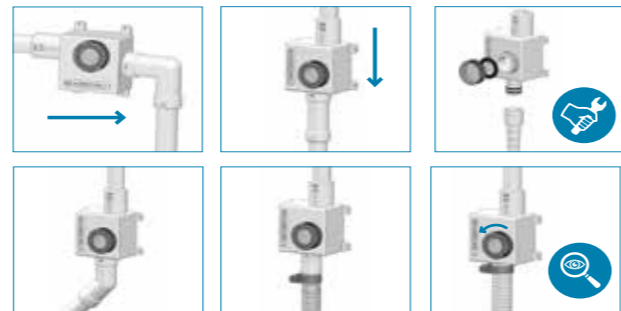
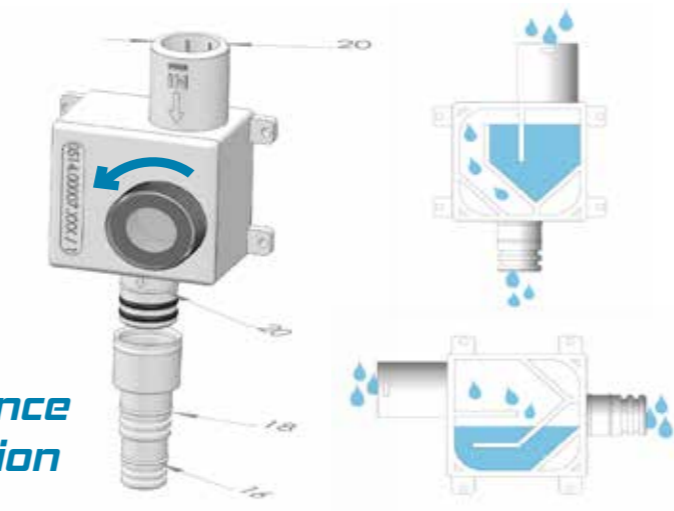
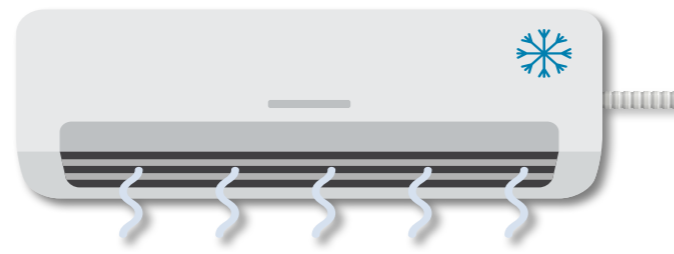

Model	RDP.SIF-OHV
Part Nr	0514.00007.022
Colour	white
A = Ø	20mm
B = Internal Ø	16 - 18mm
Packing	20 x 1 PC
Pallet	1280 pcs (64 x 20)

## Transparent 6-9 Drain Hose\*\*

○ Transparent

- > Connects to condensate water removal pumps

Model	A.DPT.95
Part Nr	0511.00201.033
Colour	Transparent
External Ø	9mm
Internal Ø	6mm
Packing	50M (ROLL)
Pallet	5000M (100 ROLL)



## Condensation hose Connection Soft-Rigid (CCSR)\*\*

- > We recommend the use of hose clamps (not supplied) to ensure watertightness

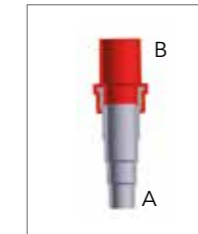

Model	CCSR.16	CCSR.18	CCSR.20	CCSR.25	CCSR.32
Part Nr	0514.00001.022	0514.00002.022	0514.00003.022	0514.00004.022	0514.00005.022
A = External Ø	14 / 16 / 18 / 20 mm	14 / 16 / 18 / 20 mm	14 / 16 / 18 / 20 mm	14 / 16 / 18 / 20 mm	14 / 16 / 18 / 20 mm
B = Internal Ø	16 mm	18 mm	20 mm	25 mm	32 mm
Colour (soft part)	Yellow	Red	Blue	Green	Grey
Packing (small)	20 pcs	20 pcs	20 pcs	20 pcs	20 pcs
Packing	300 pcs (15x20 pcs)	300 pcs (15x20 pcs)	300 pcs (15x20 pcs)	300 pcs (15x20 pcs)	300 pcs (15x20 pcs)
Pallet	9600 pcs (32 BOX)	9600 pcs (32 BOX)	9600 pcs (32 BOX)	9600 pcs (32 BOX)	9600 pcs (32 BOX)



\* Pre-mounted and pre-lubricated O-rings : CHAMFER and DEBURR the pipe before inserting it in fittings to avoid damage to the O-rings !  
 \*\* To be used only for the outlet of air conditioning condensation water (without pressure)

\*\* To be used only for the outlet of air conditioning condensation water (without pressure). CHAMFER and DEBURR the pipe before inserting it in CCSR fittings to avoid damage

## Corrugated Drain Hose\*\*

○ White

- > For the removal of air conditioning condensation water
- > Connects to Ø 16, 18 and 20mm systems
- > With regular cut marks
- > 50 M hose in a carton box

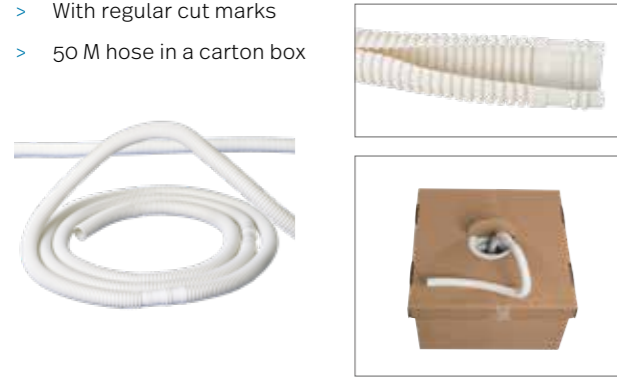

Model	A.DP.96
Part Nr	0511.00301.033
Colour	white
Connections	16 - 18 - 20 mm
Packing	50 M (BOX)
Pallet	4500 M (90 BOX)

## Condensation Connect Y\*\*

○ White

- > Connects to A.DP.96 drain hoses



Model	CCY
Part Nr	0511.00003.022
Top connections Ø	2 x 20mm
Bottom connections Ø	1 x 18mm
Packing	200 pcs
Pallet	9600 pcs (48 BOX)

## Spiral Drain Hose \*\*

○ White

- > For the removal of air conditioning condensation water
- > Smooth Inside



Model	A.DPS.16	A.DPS.20
Part Nr	0511.00101.034	0511.00102.034
Connects to	16mm	20mm
Packing	30 M (ROLL)	30 M (ROLL)
Pallet	4320 M (144 ROLLS)	3360 M (112 ROLLS)

## Condensation Connect Y Smooth\*\*

- > Connects to A.DPS Drain Hoses



Model	CCSY
Part Nr	0511.00103.022
Connections	16 - 18 - 20 mm
Packing	100 pcs (5 x 20)
Pallet	3200 pcs (32 BOX)

\*\* To be used only for the outlet of air conditioning condensation water (without pressure)

## Pre-installation Boxes with Vertical Outlet\*\*

○ White

- > Built-in box for pre-installation of air-conditioning systems
- > Connections for Ø 16, 18 and 20 mm drain pipes and hoses

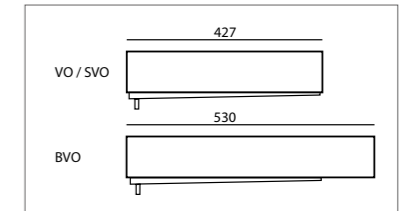
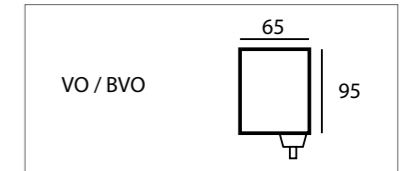

Model	E-BOX VO-L	E-BOX BVO-L
Part Nr	0510.00101.022	0510.00103.022
Colour	white	white
Dimensions (mm)	427 x 95 x 65mm	530 x 95 x 65mm
Dimensions (inch)	16,81 x 3,74 x 2,56"	20,87 x 3,74 x 2,56"
Packing	25 x 1 PC	20 x 1 PC
Pallet	500 PCS (20 BOX)	400 PCS (20 BOX)

## Pre-installation Boxes with Horizontal Outlet\*\*

○ White

- > Built-in box for pre-installation of air-conditioning systems
- > Connections for Ø 16, 18 and 20 mm drain pipes and hoses

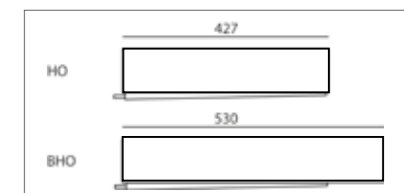
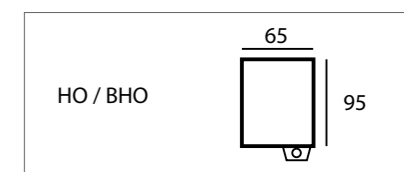

Model	E-BOX HO-L	E-BOX BHO-L
Part Nr	0510.00001.022	0510.00003.022
Colour	white	white
Dimensions (mm)	427 x 95 x 65mm	530 x 95 x 65mm
Dimensions (inch)	16,81 x 3,74 x 2,56"	20,87 x 3,74 x 2,56"
Packing	20 x 1 PC	20 x 1 PC
Pallet	400 PCS (20 BOX)	400 PCS (20 BOX)

\*\* To be used only for the outlet of air conditioning condensation water (without pressure)

## Condensation Trays

○ White

- > Tray for the collection of condensation water
- > Made from rigid UV-stabilized plastics (no rust)
- > Adjustable arm fixation
- > Moulded water outlet for Ø 16 mm, 18 mm and 20 mm.
- > Connects to standard drain pipes and drain hoses

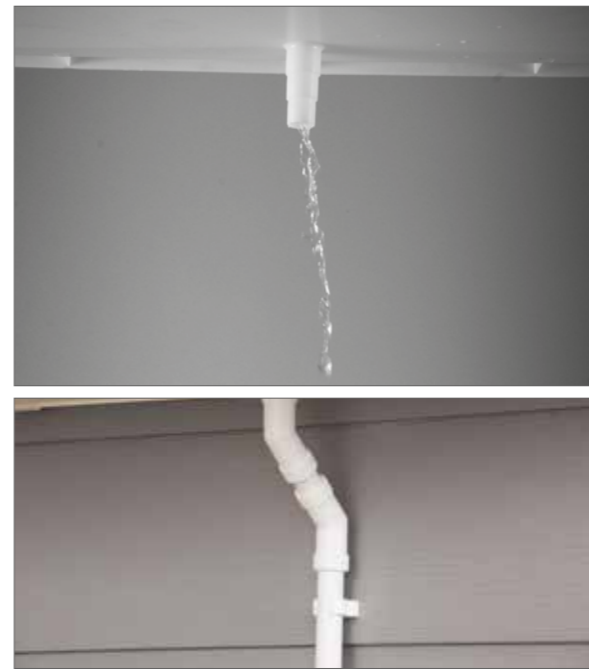

Model	TCCW-79-IND	TCCW-94-IND
Part Nr	0509.00001.032	0509.00002.031
Colour	white	white
Length (A)	790mm (31,10")	940mm (37,01")
Width (B)	390mm (15,35")	420mm (16,54")
Packing	1 PC	1 PC
Pallet	75 pcs	70 pcs

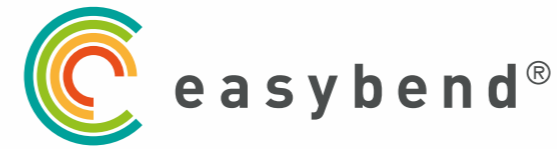

## AIR CONDITIONING LINE SET BENDER



ONLY FOR SOFT COPPER!

EASY TO USE!

REUSABLE IF CLEAN!

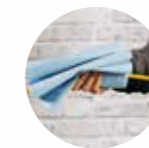
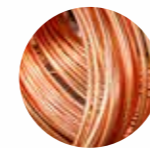

12 mm for 5/8"    9 mm for 1/2"    6 mm for 3/8"    4 mm for 1/4"

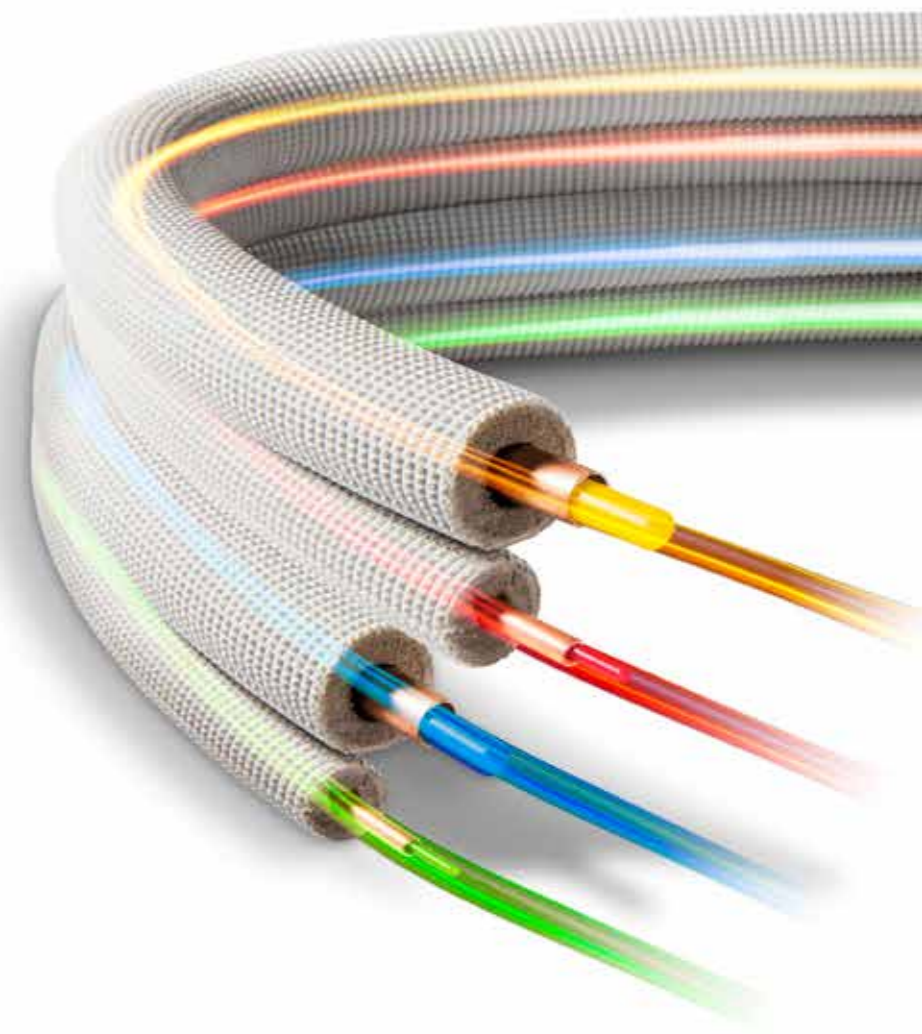

**NEW**  
**ADD-ON for 3/4"**

16 mm

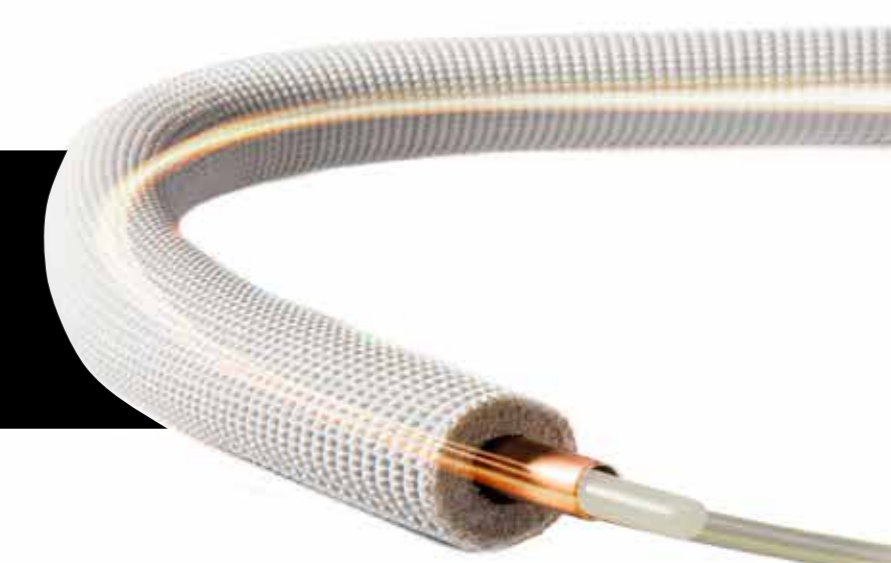

# FrameFoot®

Adjustable height

Easy to install

Equipped with plastic foot  
and anti vibration rubber mat

Galvanized steel

Personalized projects  
on request

supporting system  
for heavy-duty units



## FrameFoot® Heavy Duty

- > Heavy Duty supporting system for external units
- > Modular and Extendable

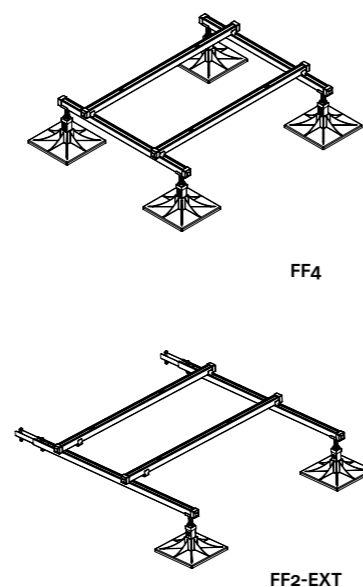

Model	FF4	FF2-EXT
Part Nr	0502.00027.004	0502.00027.002
Max spread load capacity	500 kg / M <sup>2</sup>	500 kg / M <sup>2</sup>
Packing	1 SET	1 SET

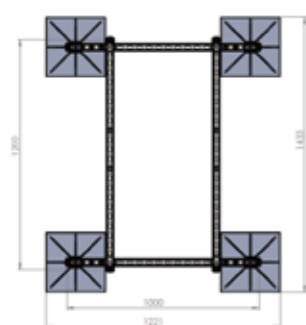

FF4

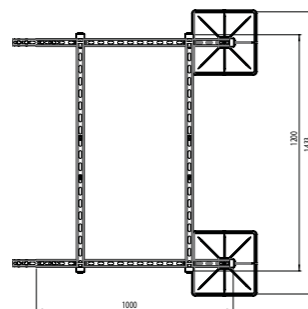

FF2-EXT

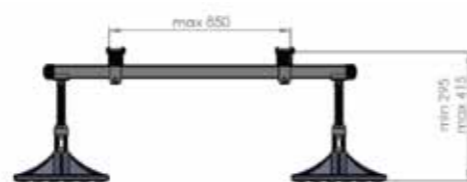

FF4

Other FrameFoot® configurations or solutions can be available on request. Contact us

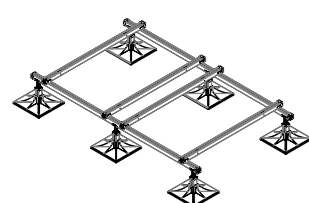

FF6

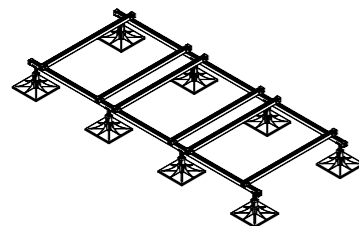

FF8

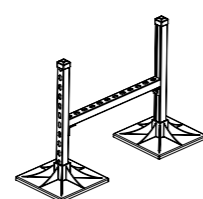

HF-600

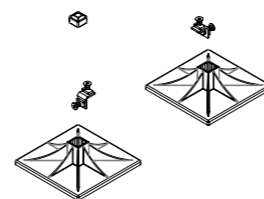

HF-DIY.01

Copyright © 2022 Castel Engineering srl - CAT.AIRC022v1-1X-F00.000000.020

Copyright © 2022 Castel Engineering srl - CAT.AIRC022v1-1X-F00.000000.020

## FrameFoot® Mini

NEW

HEAT PUMP SPECIAL

- > Compact anti-vibration stand
- > Fits particularly well heat pumps
- > Comes complete in 1 single box



Model	FF-755	FF-1250 Mono	FF-1250-VR
Part Nr	0502.00030.000	0502.00030.001	0502.00030.002
Max spread load capacity	360 kg	450 kg	450 kg
Colour	Black grey (7021)	Black grey (7021)	Black grey (7021)
Max unit Width (W) x Depth (D)	755 (29,72") x 520mm (20,47")	1250 (49,21") x 520mm (20,47")	1250 (49,21") x 820mm (32,28")
Min unit Width (W) x Depth (D)	450 (17,72") x 120mm (4,72")	690 (27,16") x 120mm (4,72")	690 (27,16") x 120mm (4,72")
Min - Max height	330 - 370mm (12,99" x 14,57")	330 - 370mm (12,99" x 14,57")	330 - 370mm (12,99" x 14,57")
Inclination (roof)	min. 0° - max. 5°	min. 0° - max. 5°	min. 0° - max. 5°
Packing	1 BOX	1 BOX	1 BOX
Pallet	40 BOX	40 BOX	30 BOX

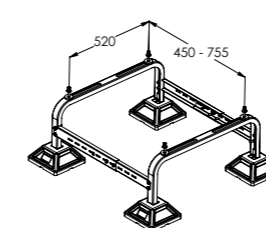

FF-755

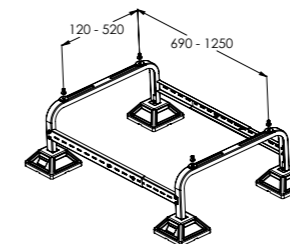

FF-1250 Mono

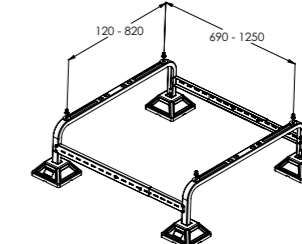

FF-1250 VR

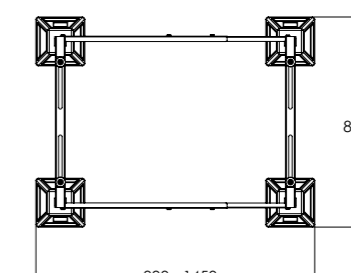
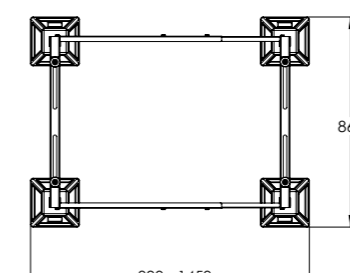
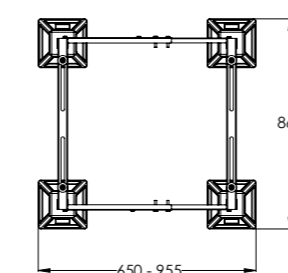
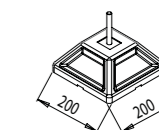
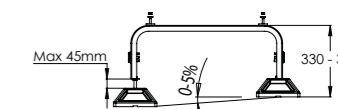

CONTACT US  
FOR



HYGIENIC ACCESSORIES  
AND CEILING SUSPENSIONS  
FOR AGRO-ALIMENTARY,  
COLD- AND CLEANROOM  
INDUSTRIES

COVINGS

BACKING PROFILES

PLINTHS

SUSPENSIONS

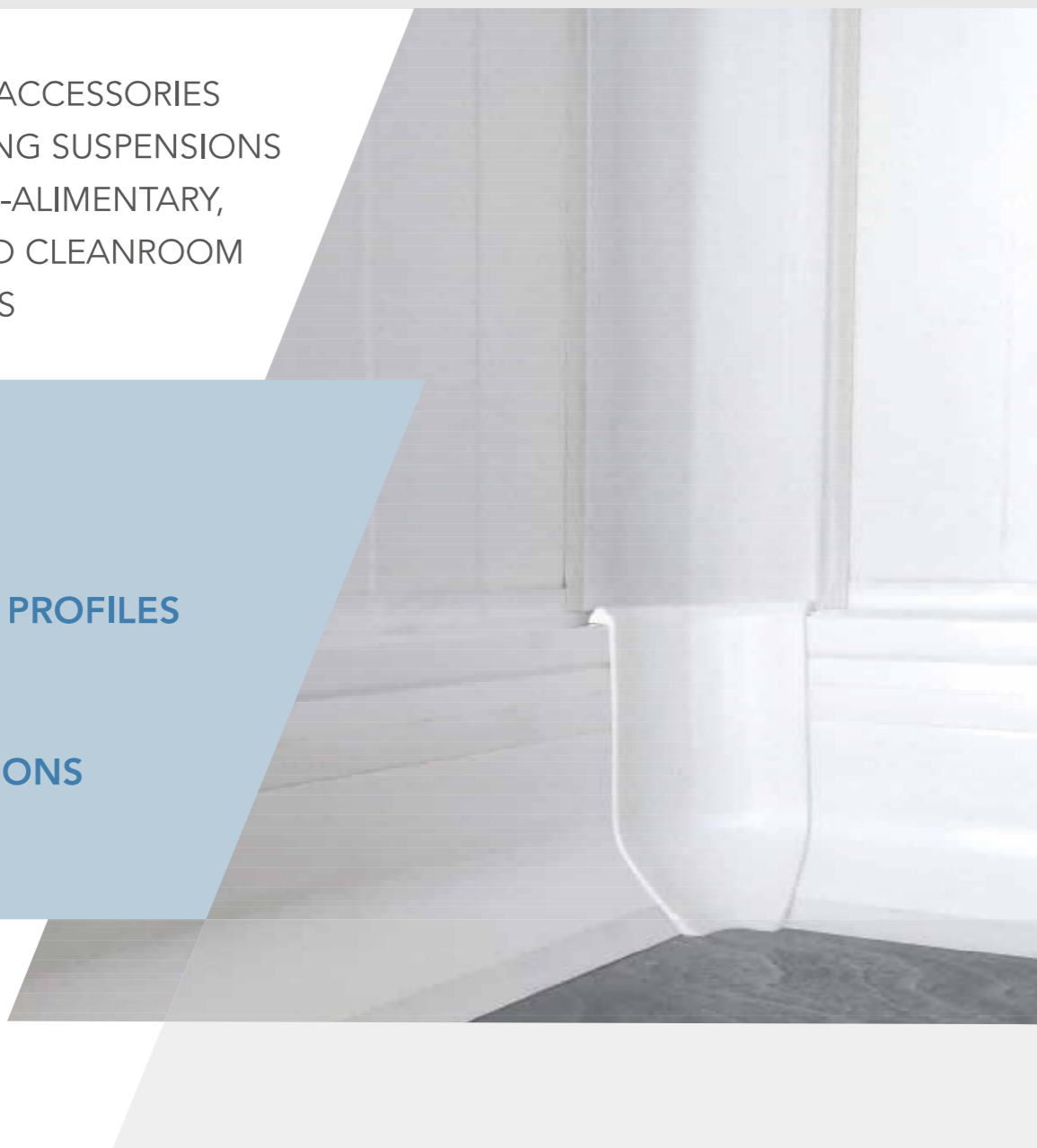

ENGINEERED QUALITY PRODUCTS  
FROM THE ORIGINAL MANUFACTURER SINCE 1987

[www.castel-engineering.com](http://www.castel-engineering.com)



Castel Engineering srl (H.Q.)  
Rue de la Royenne 84  
7700 Mouscron - Belgium  
T. +32 56 33 68 40  
info@castel-engineering.com  
**castel-engineering.com**

Castel Engineering Polska Sp. z o.o.  
Tomaszowice Kolonia 126  
21-002 Tomaszowice - Poland  
T. + 48 81 503 28 22  
biuro@castel-engineering.com  
**castel-engineering.com**

Rodigas Srl  
Via Giacomelli, 10,  
35010 Limena (Padova) - Italy  
Tel. +39 049 884 00 56  
Email. info@rodigas.it  
**www.rodigas.it/en**